



# ME-RC

## Basic Remote Control



Owner's Manual  
(Revision 2.6 or higher)

## Disclaimer of Liability

Since the use of this manual and the conditions or methods of installation, operation, use and maintenance of the ME-RC are beyond the control of Magnum Energy, Inc., this company does not assume responsibility and expressly disclaims liability for loss, damage or expense, whether direct, indirect, consequential or incidental, arising out of or in anyway connected with such installation, operation, use, or maintenance.

Due to continuous improvements and product updates, the images shown in this manual may not exactly match the unit purchased.

## Restrictions on Use

The ME-RC remote may only be used in life-support devices or systems with the express written approval of Magnum Energy. Failure of the ME-RC remote can reasonably be expected to cause the failure of that life-support device or system, or to affect the safety or effectiveness of that device or system. If the ME-RC remote fails, it is reasonable to assume that the health of the user or other persons may be endangered.

## Important Product Safety Instructions

Read all instructions and safety information contained in this manual **before** installing or using this product.

- All electrical work must be performed in accordance with local, state, and federal electrical codes.
- This product is designed for indoor/compartment installation. It must not be exposed to rain, snow, moisture, or liquids of any type.
- Use insulated tools to reduce the chance of electrical shock or accidental short circuits.
- Remove all jewelry such as rings, watches, bracelets, etc., when installing or performing maintenance on the inverter.
- Always disconnect the batteries or energy source prior to installing or performing maintenance on the inverter. Live power may be present at more than one point since an inverter utilizes both batteries and AC. Turning off the inverter may not reduce this risk. As long as AC power is connected, it will pass thru the inverter regardless of the power switch on the inverter or the ON/OFF INVERTER pushbutton on the remote.

## Safety Symbols

To reduce the risk of electrical shock, fire, or other safety hazard, the following safety symbols have been placed throughout this manual to indicate dangerous and important safety instructions.



**WARNING:** Indicates that failure to take a specified action could result in physical harm to the user.



**CAUTION:** Indicates that failure to take a specified action could result in damage to the equipment.



**Info:** Indicates information that emphasizes or supplements important points of the main text.



**Remedy:** Provides possible solutions for related issues.

## List of Contents

1.0 Overview .....	1
2.0 Installation.....	2
2.1 Installation Guidelines .....	2
2.2 Tools Required .....	2
2.3 Installation Procedure.....	2
3.0 Setup .....	4
3.1 Navigating the Remote’s Menu.....	4
3.2 Menu Pushbuttons and Menu Items .....	6
3.2.1 SHORE Menu .....	6
3.2.2 AGS Menu .....	7
3.2.3 METER Menu .....	7
3.2.4 SETUP Menu.....	8
3.2.5 TECH Menu .....	16
4.0 Menu Map: ME-RC Remote Control .....	18
5.0 Operation.....	21
5.1 Front Panel .....	21
5.1.1 LED Indicators .....	21
5.1.2 LCD Display.....	21
5.1.3 ON/OFF Pushbuttons .....	22
5.1.4 Menu Pushbuttons.....	22
5.1.5 Rotary SELECT Knob.....	22
5.2 Operating the Inverter/Charger.....	23
5.2.1 Inverter Mode.....	23
5.2.2 Charger mode .....	23
5.3 System Status Messages.....	24
5.3.1 Inverter Mode Messages .....	24
5.3.2 Charger Mode Messages.....	25
5.3.3 Fault Mode Messages .....	28
5.3.4 LED Indicator Guide .....	35
6.0 Troubleshooting .....	36
6.1 Troubleshooting Tips.....	37
6.1.1 Inverter Problems .....	37
6.1.2 Charger Problems .....	37
6.2 Performing an Inverter Reset.....	38
6.3 Powering-down the Inverter .....	38
7.0 Limited Warranty .....	39
7.1 How to Receive Repair Service.....	40

## Tables

Table 3-1, Battery AmpHrs Capacity to Absorb Time .....	10
Table 3-2, Battery Size to Battery AmpHrs (estimated) .....	11
Table 3-3, Battery Type to Charge Voltages .....	12
Table 3-4, Inverter/Charger Default Settings .....	17
Table 5-1, LED Indicator Guide .....	35
Table 6-1, Remote Control Troubleshooting Guide .....	36

## List of Figures

Figure 1-1, Front Panel Features .....	1
Figure 2-1, Remote Cut-Out Dimensions .....	3
Figure 2-2, Remote Control Connections .....	3
Figure 3-1, Front Panel Setup Features .....	4
Figure 3-2, SETUP Menu Navigation .....	5
Figure 3-3, SHORE: Shore Max Selections .....	6
Figure 3-4, AGS Menu Display .....	7
Figure 3-5, METER: 01 INV/CHG Meter Display .....	7
Figure 3-6, SETUP: 01 Search Watts Selections .....	8
Figure 3-7, SETUP: 02 LowBattCutOut Selections .....	9
Figure 3-8, SETUP: 03 Absorb Time Selections .....	10
Figure 3-9, SETUP: 04 Battery Type Selections .....	12
Figure 3-10, SETUP: 05 Charge Rate Selections .....	13
Figure 3-11, SETUP: 06 VAC Dropout Selections .....	14
Figure 3-12, SETUP: 07 Power Save Selections .....	15
Figure 3-13, SETUP: 08 Screen Setup Selections .....	15
Figure 3-14, TECH: 01 Temperatures Display .....	16
Figure 3-15, TECH: 02 Revisions Display .....	16
Figure 3-16, TECH: 03 Inv Model Display .....	16
Figure 3-17, TECH: 04 Load Defaults Selection .....	17
Figure 3-18, TECH: 05 Ext Control Display .....	17
Figure 4-1, Inverter/Charger Menu Map .....	18
Figure 4-2, Inverter/Charger Menu Map .....	19
Figure 4-3, Inverter/charger Menu map .....	20
Figure 5-1, ME-RC Front Panel Controls and Indicators .....	21
Figure 5-2, Off Mode .....	24
Figure 5-3, Searching Mode .....	24
Figure 5-4, Inverting Mode .....	24
Figure 5-5, Charging Mode .....	25
Figure 5-6, Bulk Charging Mode .....	25
Figure 5-7, Absorb Charging Mode .....	25
Figure 5-8, Float Charging Mode .....	26
Figure 5-9, Full Charge Mode .....	26
Figure 5-10, Charger Standby Mode .....	26

## List of Figures (cont.)

Figure 5-11, Equalizing Mode .....	27
Figure 5-12, Low Battery Fault .....	28
Figure 5-13, High Battery Fault .....	28
Figure 5-14, Overtemp Fault .....	29
Figure 5-15, AC Overload Fault.....	29
Figure 5-16, High Volts AC Fault .....	29
Figure 5-17, Dead Battery Charge Fault.....	30
Figure 5-18, Overcurrent Fault .....	30
Figure 5-19, FET Overload Fault.....	31
Figure 5-20, Breaker Tripped Fault.....	31
Figure 5-21, Unknown Fault .....	31
Figure 5-22, Tfmr Overtemp Fault.....	32
Figure 5-23, No Inverter Comm.....	32
Figure 5-24, StackClock Fault .....	33
Figure 5-25, Stack Mode Fault .....	33
Figure 5-26, StackPhase Fault .....	33
Figure 5-27, Internal Bridge Fault .....	34
Figure 5-28, Internal Charger Fault .....	34
Figure 5-29, Internal NTC Fault .....	34
Figure 5-30, Internal Relay Fault .....	34
Figure 6-1, Performing an Inverter Reset .....	38

### 1.0 Overview

The ME-RC remote control allows you to monitor and customize the operating parameters for your Magnum inverter/charger. It is the same remote used for all Magnum inverter/charger models in the ME, MM, MMS, MM-AE, MS, MS-AE, MS-PAE, and RD Series lines so there is no cross-platform confusion.

The ME-RC50 comes standard with a 50 foot, 4 conductor (twisted-pair) telephone cable and includes nonvolatile memory (preserves adjustable settings, even if power to the remote or inverter is removed). The Magnum remote control has all of the programming and operation functions included in an easy-to-use package.



**Info:** This manual is for the ME-RC with revision 2.6 or higher; see the *TECH: 02 Revisions* display on page 16 for information on how to determine your revision level.



*Figure 1-1, Front Panel Features*

The ME-RC is equipped with the following features:

- **LED Indicators** - The at-a-glance LEDs provide the inverter/charger status in a straightforward way.
- **LCD Display** - The LCD display is a 16 x 2 line (32 characters total), alphanumeric display used for setting up the inverter/charger operation as well as viewing current status or fault messages.
- **ON/OFF Pushbuttons (x2)** - Allows the inverter or charger to be independently and quickly enabled or disabled.
- **Menu Pushbuttons (x5)** - The menu pushbuttons allow the inverter or charger to be configured to your specific system preferences. These menus also allow simple access to menu items that can help with monitoring and troubleshooting your inverter/charger system.
- **Rotary Knob/SELECT button** - The rotary encoder knob is similar to a dash radio knob and is used to quickly scroll through and select various menu items and settings. Pushing this rotary knob allows you to select a menu item, or to save a setting once it is displayed on the LCD screen.

## 2.0 Installation

### 2.0 Installation

Before proceeding, read the entire Installation section to determine how you are going to install your ME-RC.



**WARNING:** Installations should be performed by qualified personnel, such as a licensed or certified electrician. The installer is responsible for determining which safety codes apply and for ensuring that all applicable installation requirements are followed. Installation codes vary depending on location and application.



**Info:** Review the Important Product Safety Information section on the front inside cover page before installing.

### 2.1 Installation Guidelines

- Before connecting any wires, determine the remote cable route throughout the home or vehicle/boat both to and from the inverter.
- Always check for existing electrical, plumbing, or other areas of potential damage BEFORE drilling or cutting into walls to mount the remote.
- Make sure all wires have a smooth bend radius and do not become kinked.
- If installing this remote in an boat, RV, or truck ensure the conductors passing through walls, bulkheads, or other structural members are protected to minimize insulation damage (such as chafing) which can be caused by vibration or constant rubbing.

### 2.2 Tools Required

Installing the remote control is a simple process and requires the following tools:

- Phillips screwdriver
- Level
- Drill
- Cut-out tool (knife/saw)
- Pencil
- Drill Bit (7/64")

### 2.3 Installation Procedure

1. Select an appropriate location to install the remote control. Allow ample room to access the remote's adjustment dial and to view the LEDs. Ensure the viewing angle of the display is appropriate.
2. Refer to Figure 2-1 for hole and cutout dimensions.
3. Run the remote cable between the remote and the inverter/charger. This cable is a 4-wire, twisted-pair, telephony standard with RJ11 connectors on each end. A standard telephone cable (with 4 conductors) may be substituted if the provided remote cable is not able to be used.
4. Connect the remote cable into the RJ11 Remote port (has blue label) on the inverter/charger (see Figure 2-2).
5. Ensure the inverter is off and that no AC power is connected to the inverter, and then connect the inverter to the batteries.



**CAUTION:** When connecting battery power to the inverter, all battery negative connections must be connected prior to the battery positive connections. When removing battery power from the inverter, the battery positive should be removed before any battery negative connections are disconnected. This is to prevent any communication chips/lines from becoming the DC return path to the battery – causing permanent damage to all connected accessories on the network.



## 2.0 Installation

**Summation: Ensure all Battery Negative circuits are always connected before connecting or disconnecting Battery Positive.**

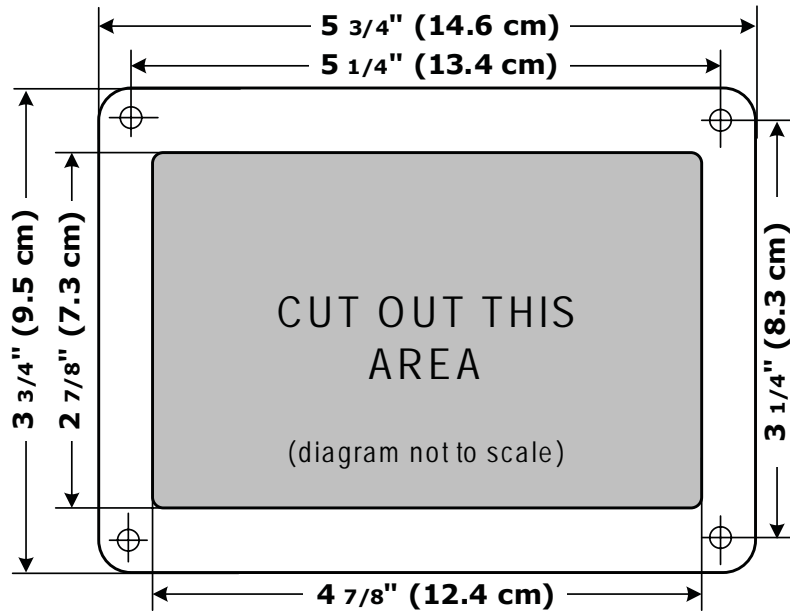
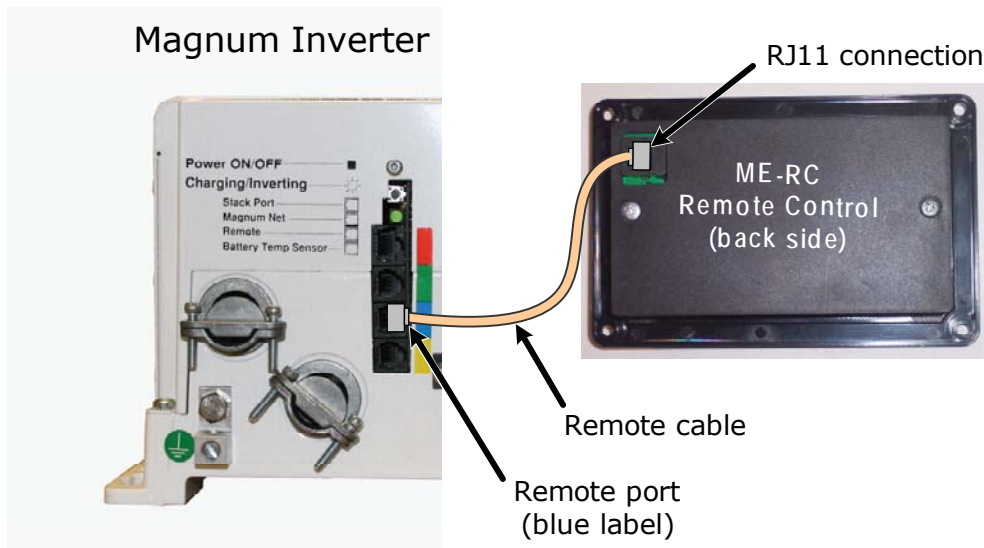

*Figure 2-1, Remote Cut-out Dimensions*



**Info:** All power to operate the remote control is provided by the inverter/charger through the remote cable.

6. While monitoring the front of the remote, connect the other end of the cable into the RJ11 jack on the backside of the remote (see Figure 2-2).
7. Immediately upon connecting the remote cable, all the LED's will come on as the unit goes through a self-test. After the initial self-test completes, text should display a system status message indicating the current state of the inverter/charger. If not, please refer to the Troubleshooting section.
8. Secure the remote to the wall using the four 6 x 3/4" screws provided.
9. The remote is ready for setup.



*Figure 2-2, Remote Control Connections*



## 3.0 Setup

### 3.0 Setup

When the remote is connected to a Magnum inverter/charger, the settings in the remote control determine the inverter/charger operating parameters. The default settings in the remote control (see Table 3-4, Inverter/Charger Default Settings) are adequate for most installations. However, you do have the option to change some of the operating parameters if required. This section will show you how to navigate the remote, give you an understanding of the function of each adjustable setting, and help you decide what setting should be used.

#### 3.1 Navigating the Remote's Menu

The ME-RC has an internal structure that provides menu items and adjustable settings that provide the ability to configure your inverter/charger to your specific parameters. See Figure 4-1 for a complete map of the inverter/charger menu items and adjustable settings.

Familiarize yourself with these items on the front panel that are used to find, adjust, and save the desired setting. They are:

- **LCD Display** - The bottom line of the LCD display shows the menu items, adjustable settings, or the meter's display information.



**Info:** The bottom line of the LCD display returns to the Home screen to show DC voltage and current (see Figure 3-1) after 2 minutes – if no buttons have been pressed.



**Info:** When the ← (left facing arrow) symbol is shown on the display, it indicates that the displayed setting has been selected and will be used.

- **Menu Pushbuttons (x5)** - These five menus allow simple access to the menu items that can help with configuring, monitoring, and troubleshooting your inverter/charger system.
- **Rotary SELECT Knob** - This knob allows you to quickly scroll through and select various menu items and settings. Pushing on the knob selects the menu item to change, or saves the current selection.



**Info:** Hold down the SELECT button for 10 seconds to refresh the LCD display.

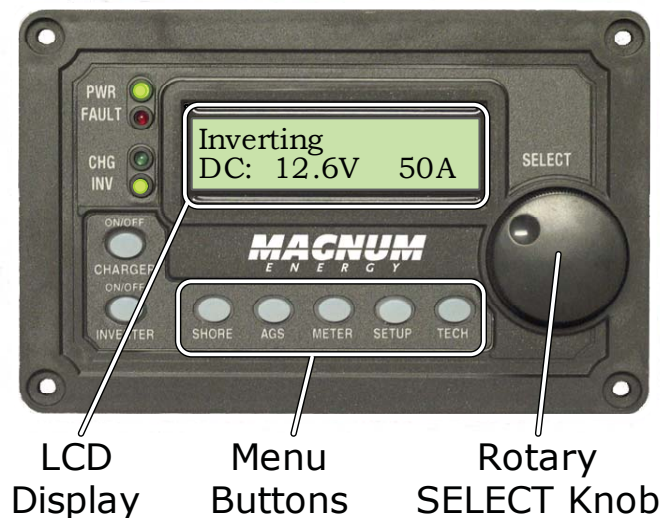

Figure 3-1, Front Panel Setup Features

### 3.0 Setup

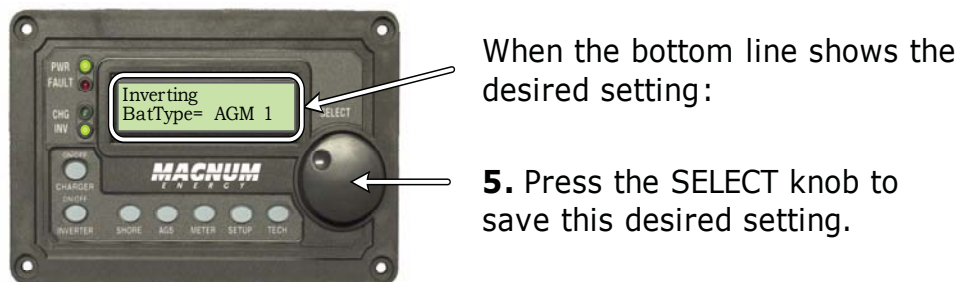
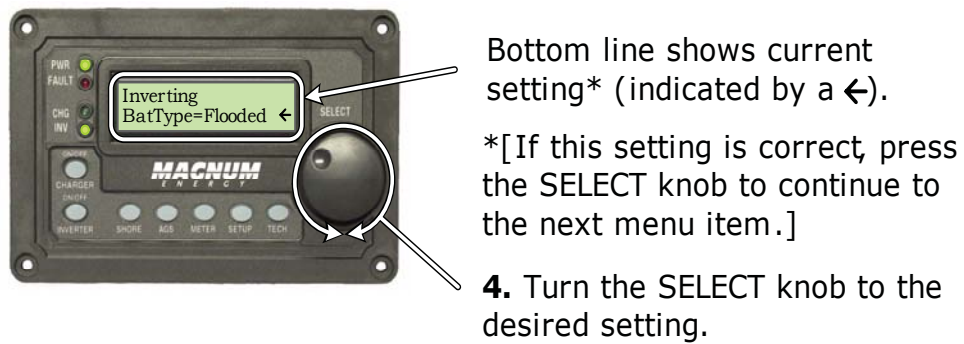
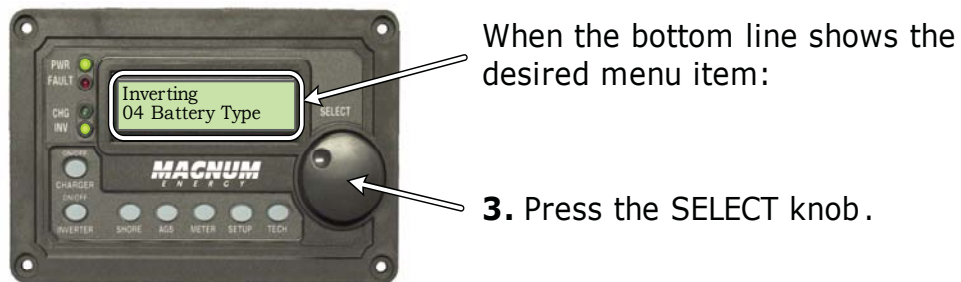
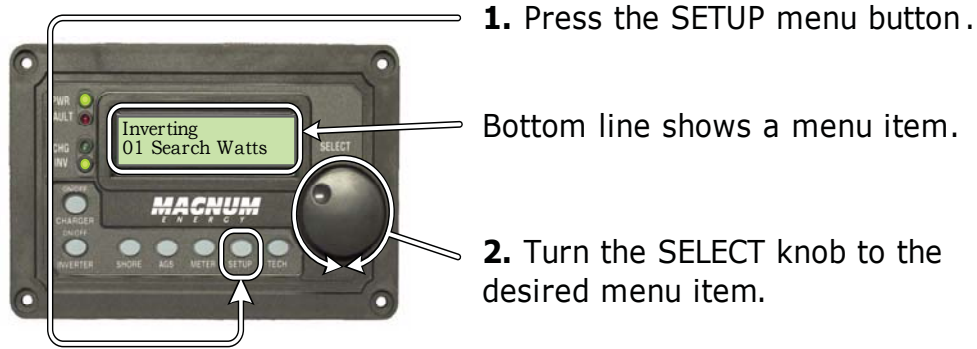

Figure 3-2, SETUP Menu Navigation

## 3.0 Setup

### 3.2 Menu Pushbuttons and Menu Items

The five menu pushbuttons (**SHORE**, **AGS**, **METER**, **SETUP**, or **TECH**) allow the inverter/charger system to be configured to your specific preferences. These menus also allow you to access menu items that can help with monitoring and troubleshooting your system.

This section will help you to understand the function of each menu pushbutton, what configurable settings are available from each menu, and whether the settings should be changed to optimize the operation of the inverter/charger.

#### 3.2.1 SHORE Menu

This menu pushbutton enables you to quickly change your *Shore Max* setting to coordinate with the circuit breaker rating from the incoming AC source.

- **SHORE: Shore Max** - This menu selection ensures the inverter AC loads receive the maximum current available from the utility or generator power. Whenever the utility or generator is connected to the inverter (thru AC HOT 1), the current used to power the AC loads and to charge the batteries is monitored. When the total current used to power the AC loads and charge the batteries begins to approach the *Shore Max* setting, the current that was used for charging the batteries will automatically be reduced. This ensures the AC loads have all the available current when needed.

**Default setting:** *Shore Max* = 30A

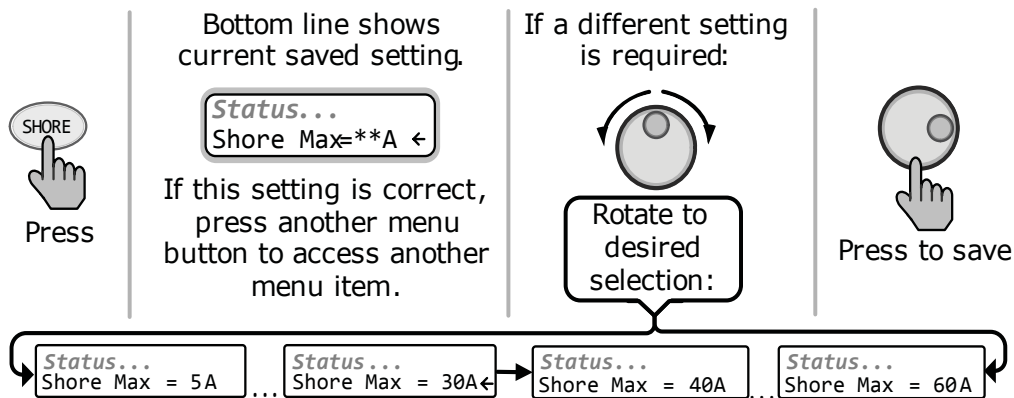

**Figure 3-3, SHORE: Shore Max Selections**

**Where to set:** Set the *Shore Max* setting to match the current rating of the utility power or generator's circuit breaker. If using multiple AC sources (utility and generator) through an AC transfer switch, adjust this setting to the smaller AC breaker size. This setting is very dependent on the stability of the AC source. If using a generator, factors such as altitude and output voltage regulation may require a lower setting than the generator's breaker size. For best performance, lower this setting to 1/3 its rated capacity and gradually increase while ensuring the voltage level stays above the SETUP menu's *06 VAC Dropout* setting.



**CAUTION:** The *Shore Max* setting does not limit the current to the inverter loads. If the current from the loads on the output of the inverter are greater than the circuit breaker rating on the incoming AC source, you may experience nuisance tripping on this breaker.

### 3.2.2 AGS Menu

The AGS menu pushbutton allows the optional Auto Generator Start - Network (AGS-N) controller (if installed and networked) to be configured to your specific system preferences, and enables you to check the status of the AGS.



**Info:** Refer to the ME-AGS-N Owner’s Manual (PN: 64-0039) for detailed information on the AGS and this menu.

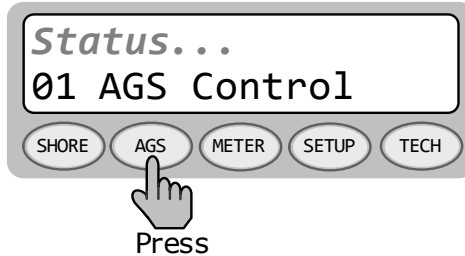

Figure 3-4, AGS Menu Display

### 3.2.3 METER Menu

Pressing the METER pushbutton provides access to the various meters that assist in determining the status of the inverter/charger and battery system.



**Info:** All displays revert back to the Home screen (except for the displays under the METER button) if no button has been pressed for approximately one minute.

- **METER: 01 INV/CHG Meter** - This menu item displays the DC voltage and current while either inverting or charging.

The *DC: V (Volts)* display provides the voltage from the batteries connected to the inverter. This reading’s accuracy is  $\pm 1.5\%$  with a 0.1 VDC resolution.

While inverting, the *DC: A (Amps)* reading displays a negative number to show the battery current used by the inverter. If you are charging, the *DC: A (Amps)* reading displays a positive number to show the amount of current delivered to the batteries. The accuracy of this display below 1 amp AC (~10 amps DC @ 12VDC) is not detected. When the current into or out of the batteries is greater than 1 amp AC, the display accuracy is  $\pm 20\%$ .

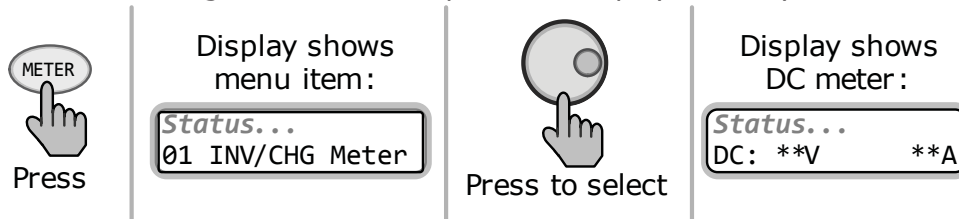

Figure 3-5, METER: 01 INV/CHG Meter Display

- **METER: 02 BM: SOC** thru **06 BM: TECH** - These menus allow the optional ME-BMK (Magnum Energy’s Battery Monitor Kit) — if installed — to be configured to your specific system preferences, and displays the status of the battery system.



**Info:** Refer to the ME-BMK/BMK-NS Owner’s Manual (PN: 64-0013) for detailed information on the Battery Monitor Kit and the available menus.

## 3.0 Setup

### 3.2.4 SETUP Menu

Pressing the SETUP menu pushbutton provides access to the menu items and settings that allow the inverter/charger to be configured. Read each menu item to determine if any setting requires adjustment to meet your requirements.

- **SETUP: 01 Search Watts** - Allows you to turn off the Search Watts feature, or adjust the power level to determine when the Search Watts feature becomes active. The power level range selection is 5W to 50W. If this feature is not needed, select *Search=Off*. When search is turned off, the inverter continuously provides full AC voltage to the loads.

**Default setting:** *Search= 5W*



**Info:** When the Search Watts feature is active, "Searching" appears on the top line of the LCD display and the green INV LED will slowly flash.

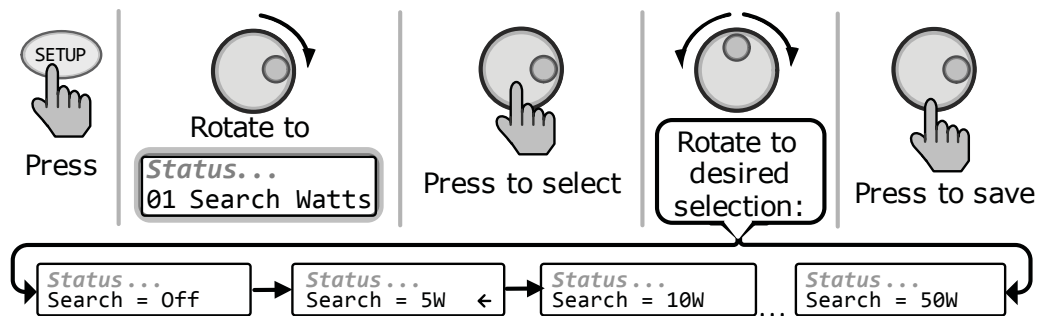

**Figure 3-6, SETUP: 01 Search Watts Selections**

**What is the Search Watts feature?** This feature is used to help save battery power by reducing the inverter's output to search pulses when there is no detectable load. If someone turns on a load greater than the wattage level setting while the inverter is searching, the inverter will start inverting to provide full voltage on its output.

**Should I use the Search Watts feature?** If the inverter can spend a great deal of time searching (to reduce the power drain on your batteries) and you can tolerate small loads (less than 5 watts) from being on, then the Search mode feature should be used. However, if you require some small load (i.e., digital clocks, satellite receivers, answering machines, etc.) to always be on, then this feature should be turned off (*Search = Off*).

**I want to use the Search Watts feature, how do I determine where to set it?** The *Search Watts* setting should be adjusted to the same power level (or the next lower setting) of the smallest load that you want to run. If you don't know the wattage of the smallest load you want to run, turn the load on and decrease the *Search Watts* setting until the load comes on and stays on.

**Example:** You review all the loads you want to run, and determine that the smallest load is a 30 watt light. Adjust the *Search Watts* setting to *Search = 30W*. Whenever you turn on any load (because all the loads are greater than 30 watts), the inverter will stop searching and start inverting to deliver power to the load.



**Info:** Even though the Search feature is on, some connected equipment — even if they are off — may draw enough current to keep the inverter in the Inverting mode.

- SETUP: 02 LowBattCutOut** - The Low Battery Cut-Out (LBCO) setting is used to set the DC voltage level that turns off the inverter to help protect the batteries from over-discharge damage. Selections are from *9.0 VDC to 12.2 VDC* (12-volt inverter models), *18.0 VDC to 24.4 VDC* (24-volt inverter models), or *36.0 VDC to 48.8 VDC* (48-volt inverter models). If the battery voltage drops below the LBCO selected set-point continuously for more than 1 minute, the fault LED will come on, the inverter will turn off, and the display will show a *Low Battery* status. If the battery voltage falls below 8.5 volts (12-volt models), 17.0 (24-volt models) or 34.0 volts (48-volt models), the fault LED and *Low Battery* status display will be immediate.

**Default settings:** LBCO = 10.0 VDC (12-volt models), 20.0 VDC (24-volt models), or 40.0 VDC (48-volt models).



**Info:** The inverter will automatically begin to start inverting when the DC voltage increases to  $\geq 12.5$  VDC (12-volt models),  $\geq 25.0$  VDC (24-volt models), or  $\geq 50.0$  VDC (48-volt models). If AC power is available and connected to the inverter's input, the inverter will automatically clear the Low Battery fault, pass the input AC power to the output and begin charging the batteries.

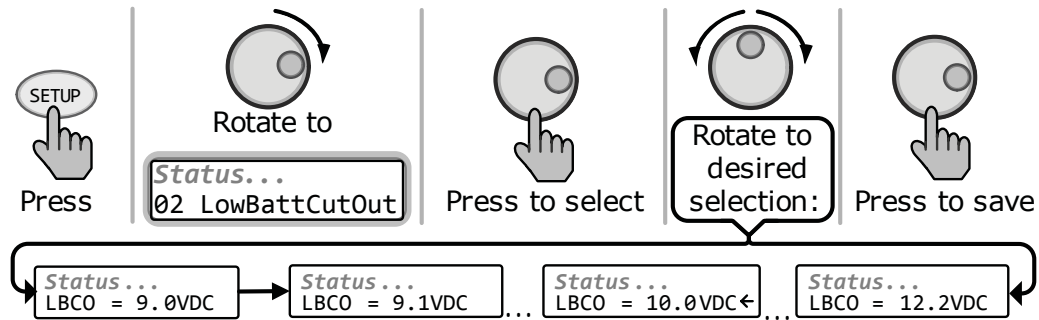

**Figure 3-7, SETUP: 02 LowBattCutOut Selections (12-volt shown)**

**Where do I set the LBCO setting?** If you want to cycle the batteries slightly – but don't want to discharge them more than 20%\*, then the LBCO setting should be set from 11.5 to 12.2 VDC (12-volt models), 23.0 to 24.4 VDC (24-volt models), or 46.0 to 48.8 (48-volt models). In some applications, such as those installed in an off-grid home or when doing a lot of dry-camping in your RV, you may want to cycle down to 50%\* by setting the LBCO from 10.0 to 11.4 VDC (12-volt models), 20.0 to 22.8 VDC (24-volt models), or 40.0 to 45.6 VDC (48-volt models). In extreme circumstances, you have the ability to discharge the batteries to 80%\* by setting the LBCO to 9.0 or 9.5 VDC (12-volt models), 18.0 or 19.0 VDC (24-volt models), or 36.0 or 38.0 VDC (48-volt models) before recharging.

\* *These discharge percentages are rough estimates. For accurate battery monitoring, a battery monitor such as Magnum's ME-BMK is required.*



**Info:** The higher the LBCO setting, the less the inverter will discharge the batteries; which should allow the batteries to have a longer life. The downside to a higher LBCO setting is that you need to charge more often to prevent the inverter from shutting down.



**Info:** If there is an AGS-N device installed, it should be set to start  $\geq 1.0$  volts higher than the LBCO setting – this is to prevent the inverter from shutting down before the generator comes on.



### 3.0 Setup

- **SETUP: 03 Absorb Time** - Used to determine when the charger completes the Absorption stage and transitions to the Float stage. Absorption is the second stage of the battery charging process and the batteries will be almost fully charged. Refer to Table 3-1 to correlate the battery capacity to the absorption time.

**Default setting:** *Absorb Hrs = 2.0*



**Info:** If the Absorption stage is short or terminated, the batteries may not receive a full charge. In contrast, if the Absorption stage is too long the batteries may be overcharged. Either scenario may cause damage to the batteries. Contact the battery manufacturer for the best charge settings for your type of batteries.



**Info:** The range of the Absorb Time setting is dependent on the revision of your inverter. With inverters having a revision 5.0 or greater, the available range to use is 0.5 to 25.5 hrs. However, if your inverter revision is less than 5.0, even though you can adjust the setting from 0.5 to 25.5 hrs, the available range is only from 1.0 to 6.5 hrs. Any setting less than 1.0 hr or greater than 6.5 hrs is not recognized and will cause the charger to revert to the default setting of 2.0 hrs.

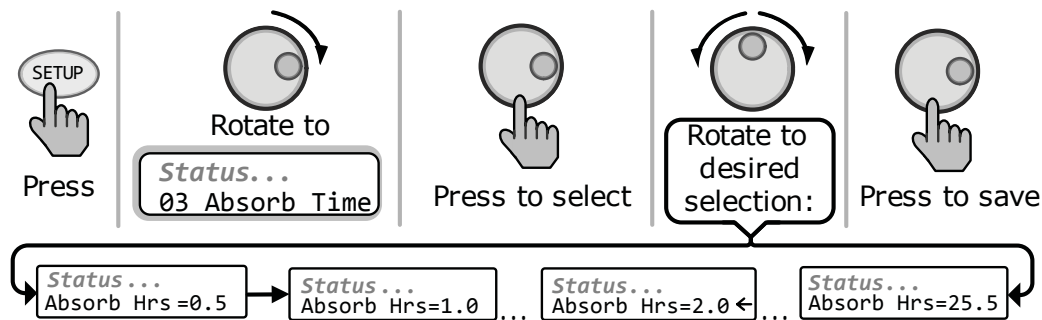

Figure 3-8, SETUP: 03 Absorb Time Selections

**Where do I set the Absorb Time setting?** Select the setting based on the 20-hour amp-hour (AH) capacity of your battery bank.

**Table 3-1, Battery AmpHrs Capacity to Suggested Absorb Time**

Battery AmpHrs Capacity	Suggested Absorb Time	Battery AmpHrs Capacity	Suggested Absorb Time
200 to 300	60 minutes	1310 to 1500	240 minutes
310 to 500	90 minutes	1510 to 1700	270 minutes
510 to 700	120 minutes	1710 to 1900	300 minutes
710 to 900	150 minutes	1910 to 2100	330 minutes
910 to 1100	180 minutes	2110 to 2300	360 minutes
1110 to 1300	210 minutes	2310 to 2500	390 minutes

**How do I determine my Battery Amp-Hour capacity?** The inverter requires deep cycle batteries, which are specifically made for continuous use. Deep cycle batteries are rated either by amp-hours or reserve capacity in minutes.

- Amp-hour (AH) capacity is a measurement of how many amps a battery can deliver for a specified length of time (usually 20 hours) until the voltage achieves 1.75 VDC/cell at 80° F.



- Reserve Capacity (RC) is a measure of how many minutes a battery can deliver a certain amount of current (usually 25A) and maintain a voltage above 1.75 VDC/cell at 80° F.



**Info:** If using the Reserve Capacity (25A), the 20-hour AH capacity can be estimated by multiplying 'minutes reserve capacity' by 50%.

Table 3-2 below provides an estimated 20-hour amp-hour capacity based on the group/code size, physical size, and voltage of the battery. If you are not sure of your battery's 20-hour AH rating, consult your battery manufacturer/dealer or use the table below to obtain an estimate.

**Table 3-2, Battery Size to Battery AmpHrs (estimated)**

Group / Code Size	Physical Size (L" x W" x H")	Battery Voltage	Battery Ahrs (20-hour rate)
GC-2 (Golf Cart)	10 3/8 x 7 13/16 x 10 5/8	6V	220 AmpHrs
L16	11 11/16 x 7 x 16 11/16	6V	375 AmpHrs
Group 22	9 1/2 x 6 7/8 x 8 5/16	12V	55 AmpHrs
Group 24	10 1/4 x 6 13/16 x 8 7/8	12V	70 AmpHrs
Group 27	12 1/16 x 6 13/16 x 8 7/8	12V	95 AmpHrs
Group 31	13 x 6 13/18 x 9 7/16	12V	110 AmpHrs
4D	20 3/4 x 8 3/4 x 9 7/8	12V	200 AmpHrs
8D	20 3/4 x 11 1/8 x 9 7/8	12V	250 AmpHrs

Once you've determined the amp-hour capacity of each battery, review how your batteries are connected (parallel or series) to determine the total amp-hour capacity of the battery bank:

**Parallel connection** - batteries connected in parallel (positive to positive, negative to negative) increase the amp-hour capacity of the battery bank, but the voltage remains the same.

**Example:** You have a 12-volt battery bank with three 12-volt batteries that are rated at 125 amp-hours (AH) each. Each of the positive terminals are connected together and each of the negative terminals are connected together, which means they are connected in parallel. The amp-hours of each battery connected in parallel are added together (125 AH + 125 AH + 125 AH = 375 AH), but the voltage of the battery bank stays the same (12 VDC).

**Series connection** - batteries connected in series (positive to negative) increase the voltage of the battery bank, but the amp-hour rate remains the same.

**Example:** You have a 12-volt battery bank with two 6-volt batteries that are rated at 220 amp-hours. The positive terminal of the first battery is connected to the negative terminal of the second battery, which means these batteries are connected in series. Since the two 6-volt batteries are connected in series, the voltage of the batteries are added together to produce 12-volts (6 VDC + 6 VDC = 12 VDC), but the amp-hour capacity of the battery bank does not change (220 AH).

In battery banks where you have batteries connected in series and in parallel, the rules are the same. The batteries connected in series are referred to as a 'series string' and the amp-hour capacity doesn't change. Each series string is connected together in parallel to increase the amp-hour capacity. Add the amp-hour capacity of each series string connected in parallel to determine the total amp-hour capacity of the battery bank.

### 3.0 Setup

- **SETUP: 04 Battery Type** - Used to select the battery type, which ensures the batteries are receiving the proper charge voltage. The fixed voltage selections are: *GEL* (for Gel batteries), *Flooded* (for liquid lead acid batteries), *AGM 1* (for Lifeline AGM batteries), and *AGM 2* (for East Penn/Deka/Discover/Trojan AGM batteries). The *Custom* selection allows the Float, Absorb, and EQ voltage settings to be individually adjusted.

**Default setting:** *BattType = Flooded*



**Info:** Settings shown in Table 3-3 are based on a Battery Temperature Sensor (BTS) temperature of 77° F (25° C) or a disconnected BTS. With the BTS connected, the actual charge voltage will increase or decrease to ensure correct charging as the battery temperature changes.

**Table 3-3, Battery Type to Charge Voltages**

Battery Type	Inverter Voltage	Absorption Voltage	Float Voltage	Equalization Voltage
GEL	12 VDC	14.1 VDC	13.6 VDC	14.1 VDC <sup>1</sup>
	24 VDC	28.2 VDC	27.2 VDC	28.2 VDC <sup>1</sup>
	48 VDC	56.4 VDC	54.4 VDC	56.4 VDC <sup>1</sup>
Flooded	12 VDC	14.6 VDC	13.4 VDC	15.5 VDC
	24 VDC	29.2 VDC	26.8 VDC	31.0 VDC
	48 VDC	58.4 VDC	53.6 VDC	62.0 VDC
AGM 1 <sup>2</sup>	12 VDC	14.3 VDC	13.1 VDC	15.5 VDC
	24 VDC	28.6 VDC	26.2 VDC	31.0 VDC
	48 VDC	57.2 VDC	52.4 VDC	62.0 VDC
AGM 2 <sup>3</sup>	12 VDC	14.5 VDC	13.5 VDC	14.5 VDC <sup>1</sup>
	24 VDC	29.0 VDC	27.0 VDC	29.0 VDC <sup>1</sup>
	48 VDC	58.0 VDC	54.0 VDC	58.0 VDC <sup>1</sup>
Custom <sup>4</sup>	12 VDC	12.0-16.0 VDC	12.0-16.0 VDC	12.0-16.0 VDC
	24 VDC	24.0-32.0 VDC	24.0-32.0 VDC	24.0-32.0 VDC
	48 VDC	48.0-64.0 VDC	48.0-64.0 VDC	48.0-64.0 VDC

Note 1: Voltage same as Absorption Voltage – to prevent equalization.

Note 2: Specifications for Concord (Lifeline Series) AGM batteries.

Note 3: Specifications for East Penn, Deka, Discover and Trojan AGM batteries.

Note 4: When using the Custom setting, the EQ (Equalization) voltage adjustment cannot be set lower than the Absorb Voltage setting. Also, the EQ voltage adjustment cannot be set higher than 2-volts (12V systems), 4-volts (24V systems), or 8-volts (48V systems) above the Absorb Voltage setting.

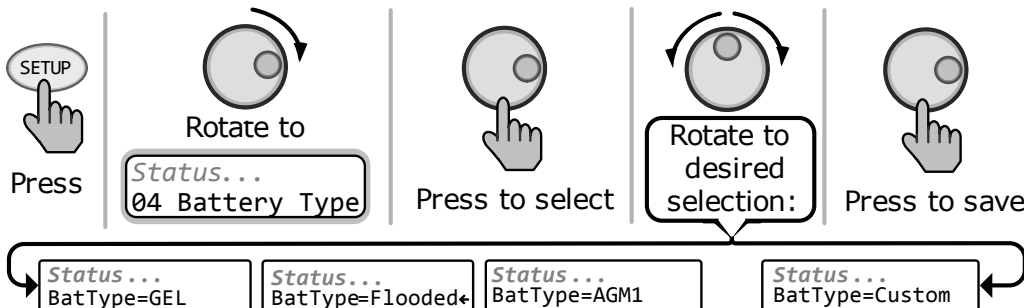

**Figure 3-9, SETUP: 04 Battery Type Selections**

- SETUP: 05 Charge Rate** - Used to set the maximum charge rate allowed to charge the batteries during Bulk, Absorption, Float, and Equalize charging. Selections are *Max Charge = 0%* up to *Max Charge = 100%*. The *Max Charge = 0%* setting helps minimize charging while continuing to allow pass-thru power. The rest of the selections are provided to limit the charge rate to the battery bank, which helps prevent battery overheating caused by charging at too high a charge rate.

The *Max Charge* selections are provided as a percentage of the inverter/charger's maximum charging capability. Refer to label on the side of the inverter or the operator's manual for the inverter/charger to determine its maximum charge rate. Once you find this maximum charge rate, determine the percentage needed to limit the charge rate to your battery-bank.

**Example:** If the maximum charge rate of your inverter/charger is 100 amps and you need to limit the charge rate to 50 amps, choose the *Max Charge = 50%* selection (50 amps = 50% of 100 amps).

**Default setting:** *Max Charge = 80%*



**Info:** If the max charge rate is set to 0%, the topology of the Magnum Inverter — when connected to an AC source — will override the 0% setting and start charging if the battery voltage is <11 VDC (12 VDC models), <22 VDC (24-volt models), or <44 VDC (48-volt models).

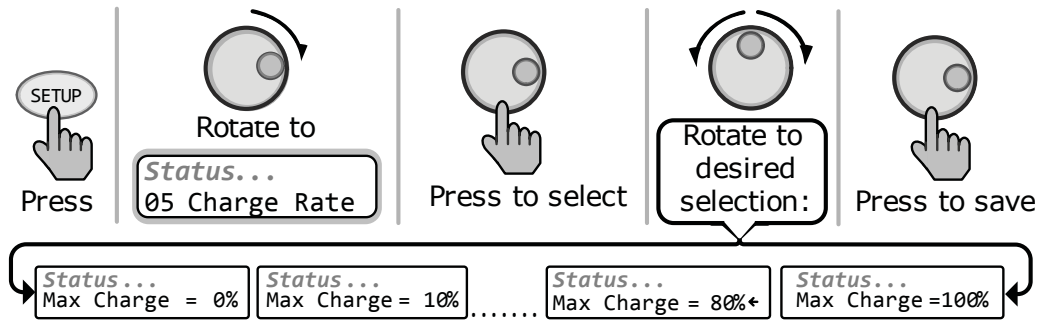

**Figure 3-10, SETUP: 05 Charge Rate Selections**

**How do I determine where to set my Maximum Charge Rate?** The maximum charge rate is generally set to a C/5\* rate (C = the total amp-hour capacity of the battery bank – using the 20-hour AH rate). The C/5 rate is usually used when the objective is to charge the batteries as quickly as possible (i.e., 400 AH ÷ 5 = 80 amp maximum charge rate). A lower rate such as C/20\* is used when the batteries need to be charged as slow as possible.



**CAUTION:** The C/5 or C/20 charge rate settings are guidelines; they are not requirements on how you should set your battery charge rate. For specific charge rate requirements, refer to your battery manufacturer.



**Info:** If multiple inverter/chargers are used on a single battery bank, you must ensure that the total charge rate from all inverter/chargers is limited to the maximum charge rate needed for your battery bank. The maximum charge rate only limits the charging on each inverter/charger individually, not on all inverter/chargers.

\* C/5 or C/20 rate – Charge rates are commonly expressed as a ratio of the total amp-hour (AH) capacity of the battery bank. For example, with a 400 AH battery bank (C = 400), the C/5 charge rate is 80 A (400/5 = 80 A).

### 3.0 Setup

- **SETUP: 06 VAC Dropout** - Used to select the minimum AC voltage that must be present on the input before the inverter/charger switches from Inverter to Charge mode.

**Example:** If this setting is set to *Dropout = 60 VAC*, then the AC input voltage must be above 60 volts before the inverter will switch from Inverter mode to Charge mode.

This setting also determines the minimum AC voltage threshold where the charger disengages and the inverter (when turned on) will provide AC power from the batteries. This protects AC loads from utility outages.

**Example:** If this setting is set to *Dropout = 60 VAC*, when the AC input voltage drops to 60 volts the inverter will switch from Charge mode to Inverter mode.

Settings are *Dropout = 60 VAC to 100 VAC* for 120 VAC inverters (or *Dropout = 120 VAC to 200 VAC* for export models), and *Dropout = UPSmode*.

**Default setting:** *Dropout = 80 VAC* (export inverter models = 150 VAC)

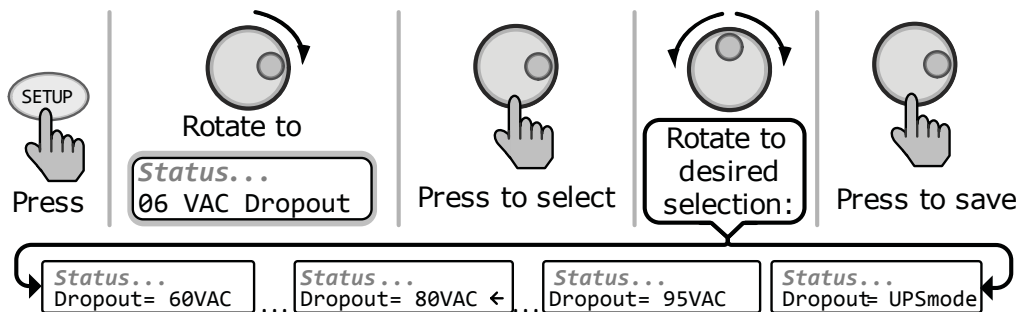

Figure 3-11, SETUP: 06 VAC Dropout Selections

**Where do I set my VAC Dropout?** It depends on the application and what you are using as the AC source. The settings not only look at the incoming voltage level to determine when to transfer, but also determines how quickly the charger disconnects and starts inverting based on the fluctuations of the incoming AC voltage.

**Dropout = 60 VAC to 100 VAC (export inverter models - Dropout = 120 VAC to 200 VAC):** Use a VAC dropout setting from 60 VAC to 100 VAC (export models - dropout from 120 VAC to 200 VAC) when the AC source may have fluctuations in RMS voltage. These settings attempt to prevent the charger from disengaging unnecessarily due to poor quality voltage; and, are highly recommended if using a generator for charging. The transfer time from Charge mode to Inverter mode is >16 milliseconds when using these settings.

**Dropout = UPSmode:** Use the *UPSmode* setting when the AC source is well regulated above 105 VAC (210 VAC for export inverter models) and the inverter loads are sensitive to voltage fluctuations. This setting is intolerant of voltage fluctuations and will provide a quick transfer. The transfer time from Charge mode to Inverter mode is ≤16 milliseconds when using this setting. For generator charging, do not use this setting.



**Info:** If you get nuisance AC disconnects, either change the setting to 100 VAC or less (export inverter models - 200 VAC or less), or obtain a better voltage regulated AC source.

- SETUP: 07 Power Save** - This setting allows you to turn off the Power Save feature, or select the time (from *1 minute* to *60 minutes*) that determines how often the display goes into Power Save mode.

**Default setting:** *PwrSave = 15min*

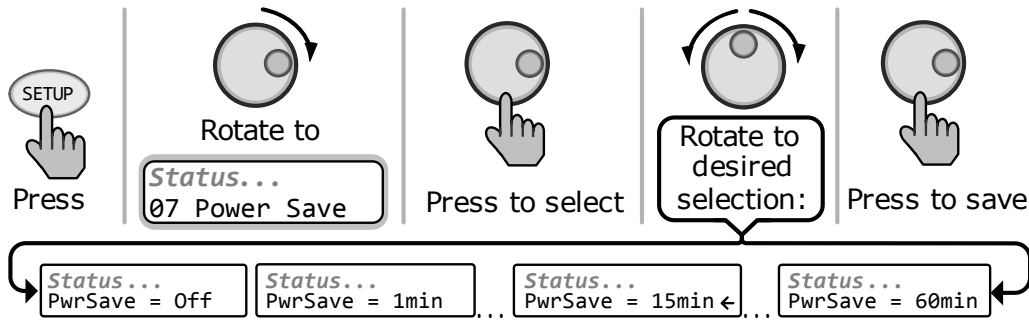

**Figure 3-12, SETUP: 07 Power Save Selections**

**What is the Power Save feature?** The Power Save feature causes the LCD backlight and LED's on the remote display to turn off to conserve energy. The remote goes into Power Save mode if there hasn't been a pushbutton press or fault message for a period of time (this time is determined by the *SETUP: 07 Power Save* setting). Whenever the remote goes into the Power Save mode, the LCD backlight and LED's can be reactivated by pressing any menu pushbutton. If you have a fault during the Power Save mode, the LCD backlight and Fault LED will come on and stay on as long as the fault is detected.

If you want the LCD backlight and LED's to always be on, you will need to turn the Power Save feature off by selecting *PwrSave = Off*.

- SETUP: 08 Screen Setup** - Used to adjust the contrast of the LCD screen and the backlight brightness for the best looking display based on the current lighting conditions and viewing angle.

**Default settings:** *Contrast = 100%; Brightness = 50%*

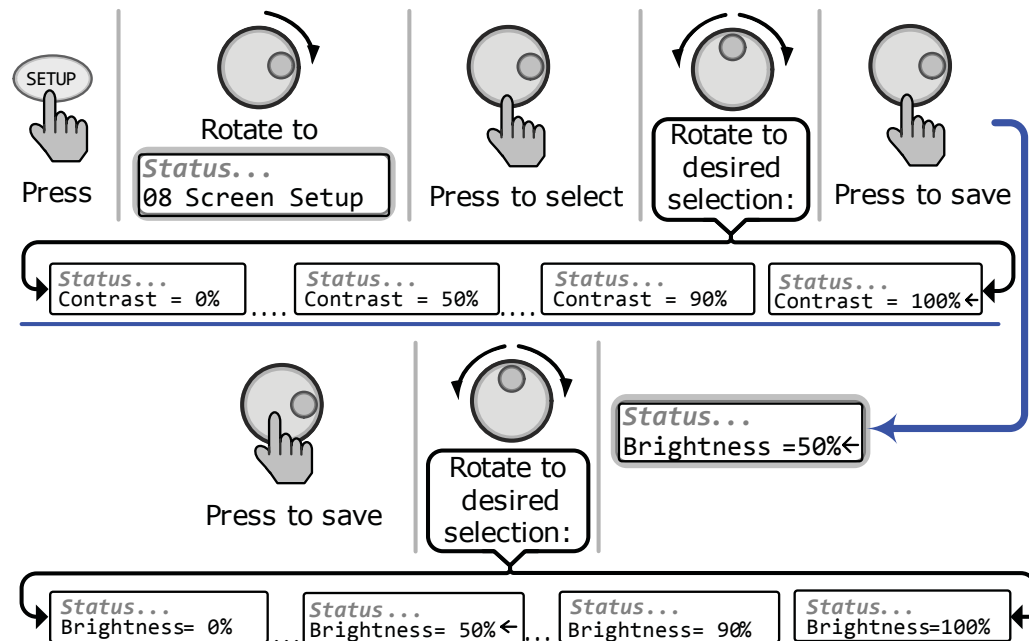

**Figure 3-13, SETUP: 08 Screen Setup Selections**

## 3.0 Setup

### 3.2.5 TECH Menu

The TECH menu pushbutton provides access to selections that are used to assist service technicians in troubleshooting. It provides access to system information along with a selection that allows all system settings to be returned to the original factory default values.

- **TECH: 01 Temperatures** - This 'read only' menu displays temperature readings of the battery temperature sensor (if connected), the transformer, the FET's (Field Effect Transistors), and a networked AGS (if installed).

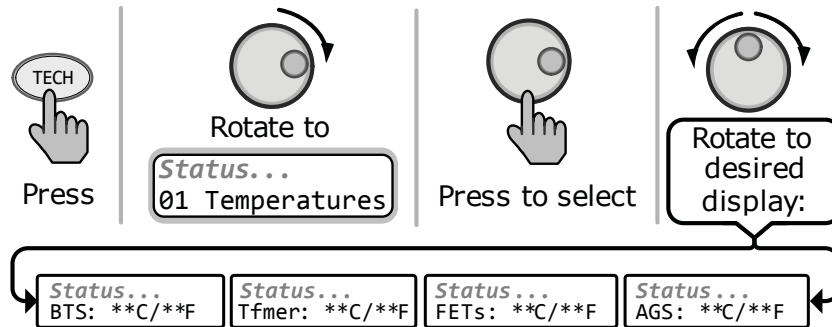

Figure 3-14, TECH: 01 Temperatures Display

- **TECH: 02 Revisions** - This 'read only' menu displays the firmware revision level of the inverter, remote, and any optional accessory (i.e., AGS, BMK) that is installed and networked.

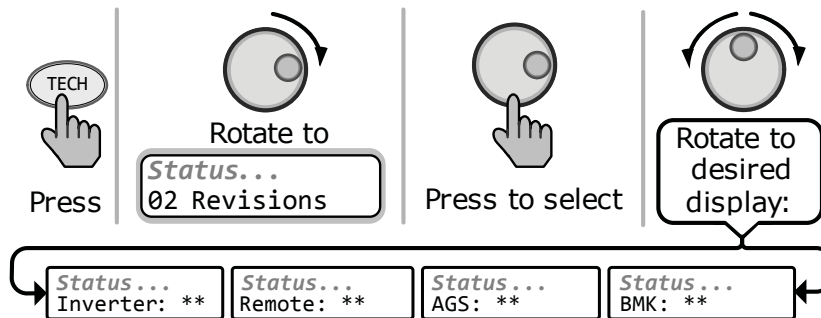

Figure 3-15, TECH: 02 Revisions Display

- **TECH: 03 Inv Model** - This 'read only' menu displays the model number of the connected inverter.

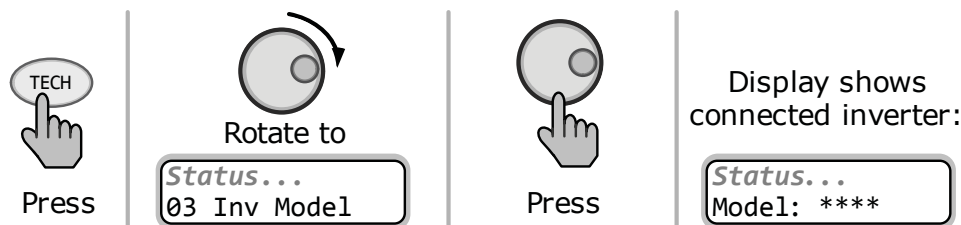

Figure 3-16, TECH: 03 Inv Model Display



**Info:** When "Model: UNKNOWN" is displayed, the remote is not able to determine the inverter model due to an older inverter model, or an inverter revision newer than the remote. All remote menu selections and features that are available in the inverter will function normally.



- TECH: 04 Load Defaults** - This menu restores all settings on the inverter/charger, and any settings on accessories that are networked and controlled by the inverter (i.e., ME-AGS-N) to the factory default settings. To restore, press and hold the rotary SELECT knob for 5 seconds. Once restored, the display will show *DEFAULTS LOADED*. The inverter/charger factory defaults are listed in Table 3-4.



**Info:** For information on the factory default settings for any networked accessory, refer to the owner's manual for that accessory.

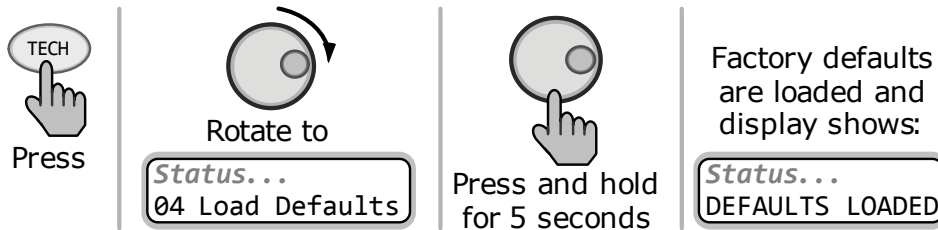

Figure 3-17, TECH: 04 Load Defaults Selection

Table 3-4, Inverter/Charger Default Settings

Menu Items		Default Settings
<b>SHORE Pushbutton</b>		Shore Max = 30A
<b>SETUP Pushbutton</b>	01 Search Watts	Search = 5W
	02 LowBattCutOut	LBCO = 10.0 VDC (12-volt models), 20.0 VDC (24-volt models), or 40.0 VDC (48-volt models)
	03 Absorb Time	Absorb Hrs = 2.0
	04 Battery Type	BatType = Flooded
	05 Charge Rate	Max Charge = 80%
	06 VAC Dropout	Dropout = 80VAC (150VAC for export models)
	07 Power Save	PwrSave = 15min
	08 Screen Setup	Contrast = 100% Brightness = 50%

- TECH: 05 Ext Control** - This 'read only' menu displays whether certain adjustable settings are being controlled internally (INT) by the Magnum Network, or externally (EXT) by an external communications device.

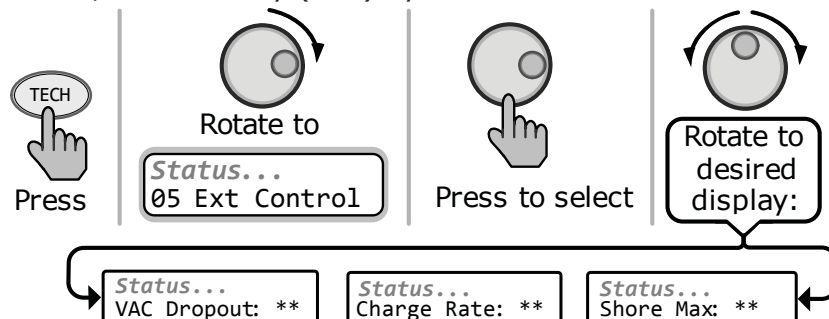

Figure 3-18, TECH: 05 Ext Control Display



## 4.0 Menu Map

### 4.0 Menu Map: ME-RC Remote Control

The following figure is a complete overview of the inverter/charger settings and info displays available in the ME-RC; this should help with menu navigation.

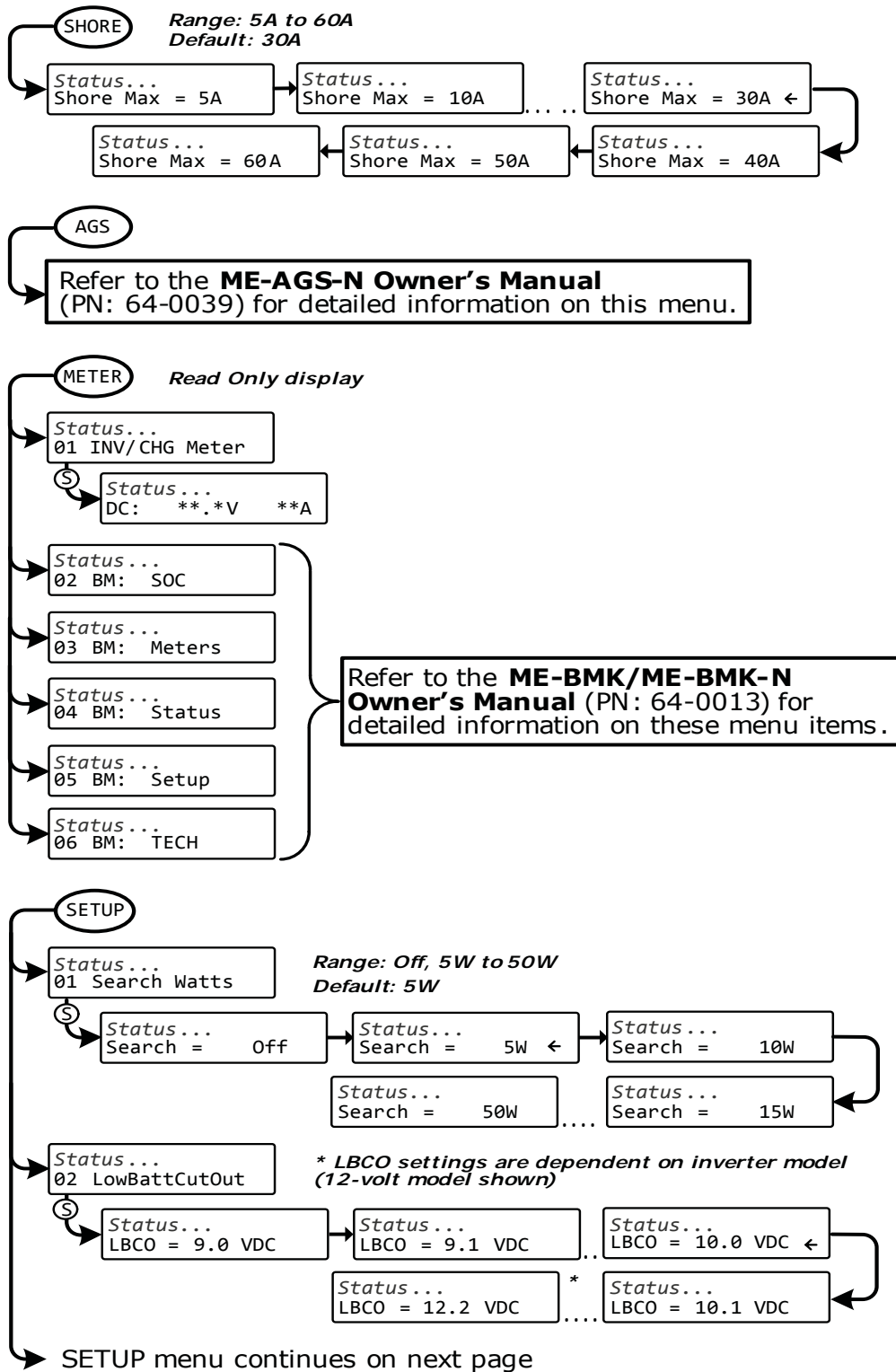

Figure 4-1, Inverter/Charger Menu Map (Page 1 of 3)

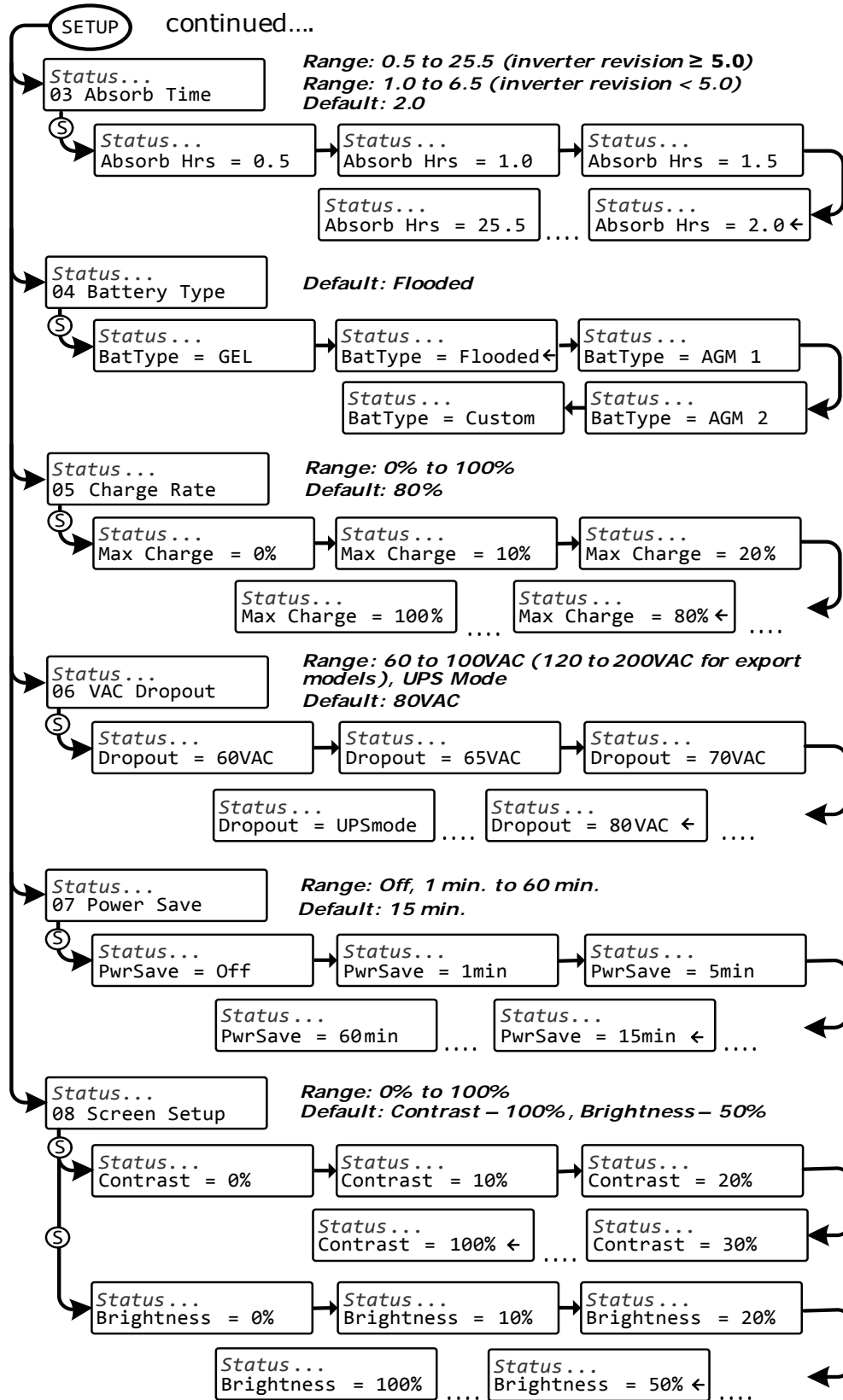

Figure 4-1, Inverter/Charger Menu Map (Page 2 of 3)

## 4.0 Menu Map

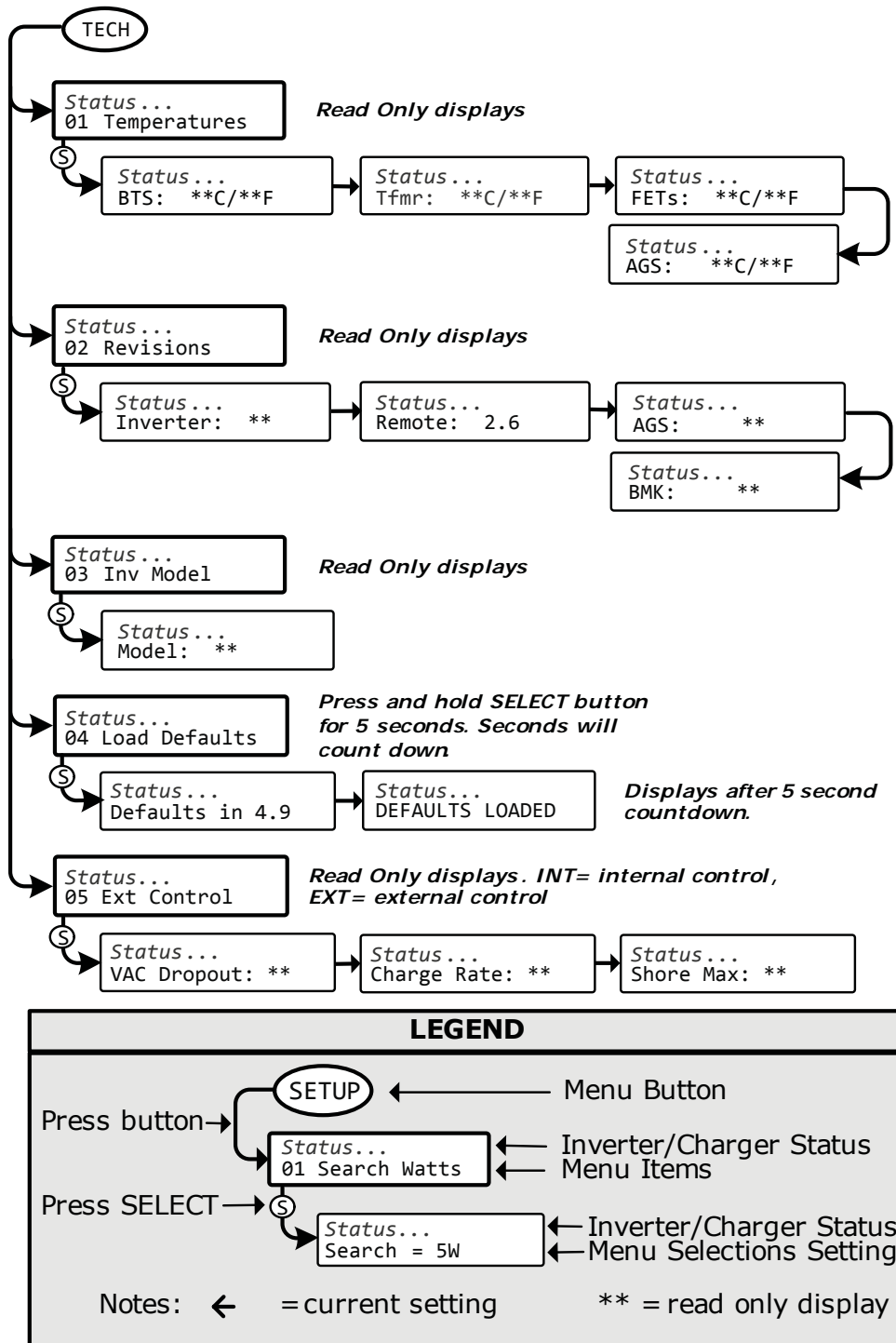

Figure 4-1, Inverter/Charger Menu Map (Page 3 of 3)

## 5.0 Operation

This section explains how to operate the inverter/charger. It also reviews each operational status determined by the LED indicators and LCD display.

### 5.1 Front Panel

The ME-RC front panel contains LEDs and a LCD display for viewing system status, pushbuttons to control system operation, and a rotary knob that allows an easy way to select and find system information.

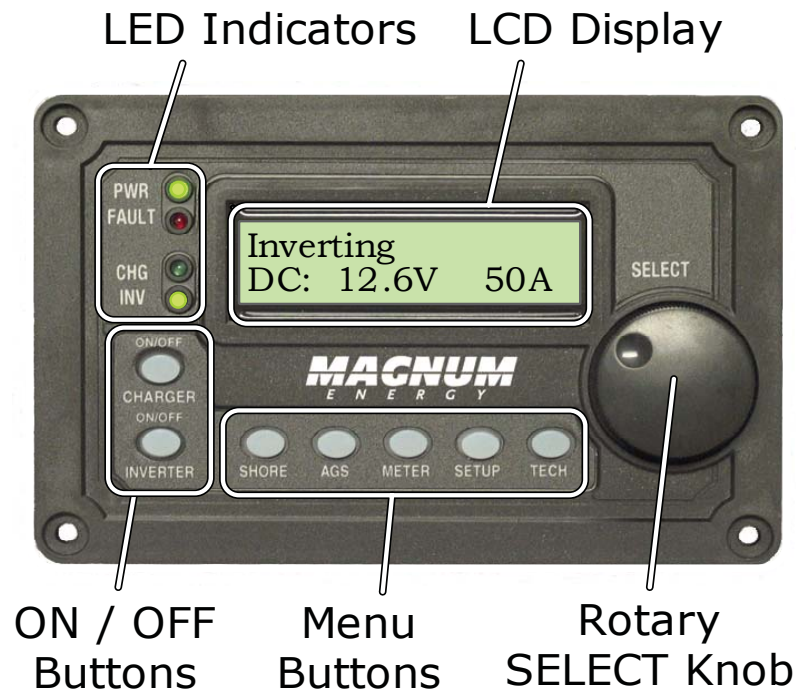

*Figure 5-1, ME-RC Front Panel Controls and Indicators*

#### 5.1.1 LED Indicators

There are four LED indicators on the front panel that light solid or blink to indicate the inverter/charger's status. When the remote is first powered-up, all the LED's come on as it goes through a self-test. Once the self-test is complete, the LED's along with the LCD provide the operating status of the inverter/charger. See Section 5.3.4 for the LED Indicator Guide.

#### 5.1.2 LCD Display

The LCD display is used for setting up the system operation as well as viewing the current operating status, or any fault condition. This display has two lines of alphanumeric characters and features a backlight that can be set to turn off to conserve power. The top line provides the inverter/charger status, which is detailed in this section. The bottom line displays battery information while using the METER menu, system troubleshooting information while in the TECH menu, and menu items that can be configured for your specific system operation while in the SETUP menu. This display automatically powers up with the current system status on the top line and the Home screen (detailing the inverter's DC voltage and current as shown in Figure 5-1) on the bottom line.

## 5.0 Operation

### 5.1.3 ON/OFF Pushbuttons

- **ON/OFF INVERTER:** This pushbutton toggles the inverter function on and off. The green INV LED turns on and off with the pushbutton.
- **ON/OFF CHARGER:** This pushbutton toggles the charger function on and off whenever the charger is actively charging. The green CHG LED turns on and off with this pushbutton. This pushbutton is also used to initiate an Equalize charge. For more information on using the Equalize charge feature, see Section 5.2.2 and the Equalizing mode information on page 27.

### 5.1.4 Menu Pushbuttons

These five menu pushbuttons provide quick access to menu items that can help with configuring, monitoring and troubleshooting your inverter /charger system.

- **SHORE:** This pushbutton allows you to set the appropriate breaker size for the incoming utility/shore power and is used to control the amount of AC amps the battery charger uses from the HOT 1 IN input. See Section 3.2.1 for more detailed information.
- **AGS:** This pushbutton allows the networked Auto Generator Start (ME-AGS-N) controller to be configured to specific system preferences and check status of the AGS (when connected). Refer to the ME-AGS-N Owner's Manual (PN: 64-0005) for detailed information on this menu.
- **METER:** This pushbutton provides meter information on the inverter/charger system. See Section 3.2.3 for more detailed information.
- **SETUP:** This pushbutton allows the inverter/charger to be configured to your specific system preferences. See Section 3.2.4 for more detailed information.
- **TECH:** This pushbutton allows you to access menu selections that can help service personnel with troubleshooting and also allows the factory default setting to be restored. See Section 3.2.5 for more detailed information.

### 5.1.5 Rotary SELECT Knob

The Rotary SELECT Knob is similar to a dash radio knob and is used to easily view and select various menu items and settings displayed on the LCD screen. Turn the rotary knob clockwise and counterclockwise to view the different menu items and the available charger and inverter settings. Push the SELECT knob to select a menu item or to save a setting once they are displayed on the LCD screen.



**Info:** All adjustable inverter/charger settings in the ME-RC (except for the *SHORE: Shore Max* and *SETUP: 08 Screen Setup* settings – which revert back to default) are saved in nonvolatile memory and are preserved until changed. This is true even if an inverter reset is performed, or if all power to the remote or inverter is removed.



**Info:** The LCD display can be refreshed by holding down the SELECT knob for 10 seconds.



**CAUTION:** An accessory that is networked to the inverter may have adjustable settings that revert back to default if all power to the inverter is lost. Refer to the operation manual for the particular accessory to determine if any setting for the accessory is affected.

### 5.2 Operating the Inverter/Charger

#### 5.2.1 Inverter Mode

**Turning the inverter on:** Press the ON/OFF INVERTER pushbutton to activate the inverter function. The inverter will either be actively inverting by using power from the batteries to power the AC loads (see Figure 5-4), or will be searching for a load by using very little power from the batteries – if in Search mode (see Figure 5-3). The green INV LED will be on when the inverter is actively inverting and will flash while searching.

**Turning the inverter off:** While the inverter is actively inverting or searching, the ON/OFF INVERTER pushbutton can be pressed to switch the inverter function off. This will turn the green INV LED off (see Figure 5-2).

**Inverter Standby:** The inverter is in standby when the inverter is active (green INV LED is on) and an external AC power (utility/shore or generator) is passing through the inverter to power the AC loads. During normal operation, the AC loads will be powered by the external AC power. However, if a blackout or brownout condition occurs, the inverter senses these conditions, transfers to Inverter mode and powers the AC loads connected to the inverter.



**CAUTION:** If you have critical loads and are in Inverter Standby, **do not** press the ON/OFF INVERTER pushbutton to turn the inverter function off. If the green INV LED is off, inverter power will **not** be available to run your critical loads if the external AC power is interrupted.

#### 5.2.2 Charger Mode

**Turning the charger on:** The charger will automatically be activated and begin to charge your batteries when acceptable AC power (utility/shore or generator) is connected to the input (HOT IN 1) of the inverter. When the charger is ON, it produces DC voltage and current to charge your batteries. The CHG LED will be on when the charger is ON and actively charging. While charging, the display will show *Bulk*, *Absorption*, *Float*, or *Full Charge* (see Figures 5-5 thru 5-9).

**Charger Standby:** While the charger is actively charging, the ON/OFF CHARGER pushbutton can be pressed to switch the charger to Charger Standby. While the charger is in Charger Standby, the incoming AC is still available on the inverter's output, but the charger is not allowed to charge. The display will show *Charger Standby* and the CHG LED will flash when the charger is in Standby mode (see Figure 5-10).



**Info:** To resume charging, momentarily press the ON/OFF CHARGER button, or disconnect/reconnect AC power to the inverter's input.

**Equalize charging:** Equalizing is a controlled overcharge performed after the batteries have been fully charged. It helps to mix the battery electrolyte (to reverse the buildup of stratification) and to remove sulfates that may have built up on the plates. These conditions if left unchecked, will reduce the overall capacity of the battery.



**WARNING:** Do not perform an Equalization charge without reading and following all safety precautions pertaining to charging/equalization as noted in this manual and any equalization information in your inverter's owner's manual.

To enable the Equalization charge, see Figure 5-11 and the info on page 27.

## 5.0 Operation

### 5.3 System Status Messages

The remote control uses the top line of the LCD display to show a status message identifying the inverter/charger's current operation. This section will show the inverter/charger's operating modes and the available status messages under each mode. Use these status messages, along with the Status LED's, to determine the inverter/charger's current operating status and to help troubleshoot the system if a fault occurs.

There are three operating modes of the inverter/charger:

- Inverter mode
- Charger mode
- Fault mode

#### 5.3.1 Inverter Mode Messages

The inverter/charger will be in Inverter mode when AC power (shore/utility or generator) is not available or unacceptable to the inverter/charger's input. The Inverter mode messages are *Off*, *Searching*, and *Inverting*.

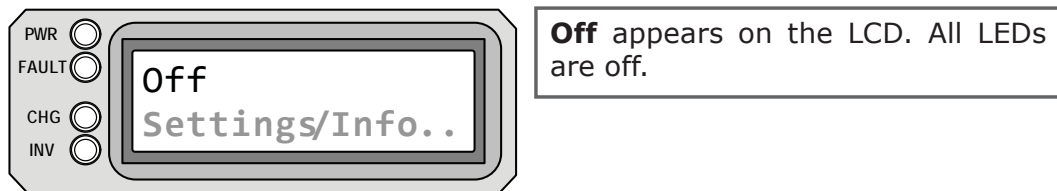

Figure 5-2, Off Mode

- **Off** - There is no AC available on the inverter's AC output. The inverter function is off, and there is no utility/shore or generator AC power sensed on its input.

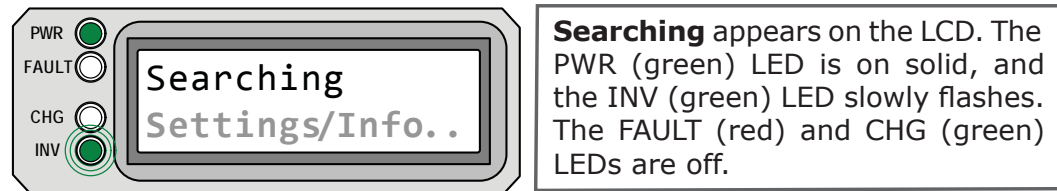

Figure 5-3, Searching Mode

- **Searching** - The inverter is in the Search mode. The AC loads on the inverter output are less than the SETUP menu's *01 Search Watts* setting. The Search mode function is used to reduce the inverter draw from the battery, and may be turned off at any time if you want full inverter output voltage available at all times (see the Search Watts section on page 8).

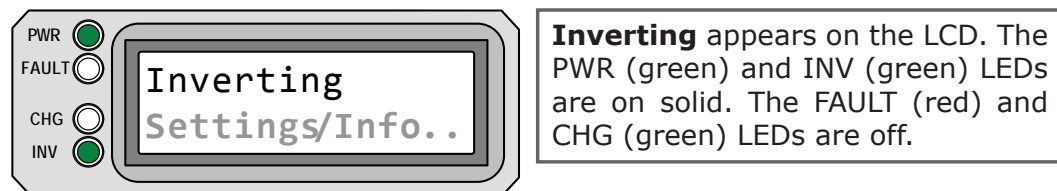

Figure 5-4, Inverting Mode

- **Inverting** - The inverter is providing AC voltage on its output by inverting power from the batteries.



### 5.3.2 Charger Mode Messages

When AC power (utility or generator) is connected to the inverter/charger, it begins to monitor the AC input for acceptable voltage. Once the AC input is accepted, the AC transfer relay (inside the inverter) closes and Charger mode begins. There are several Charger mode messages; view the top line of the LCD display and the corresponding message in this section to determine the particular Charger mode.



**Info:** The AC input becomes acceptable after a minimum 10 second delay and when the voltage is greater than the SETUP menu's *06 VAC Dropout* setting.

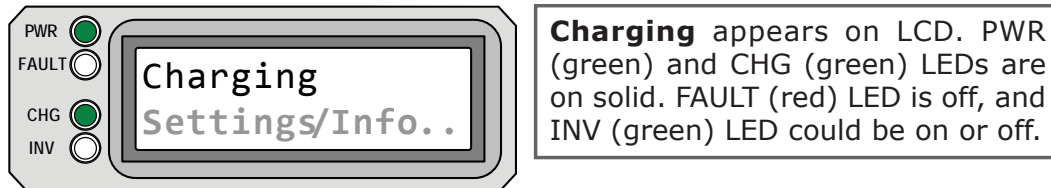

**Charging** appears on LCD. PWR (green) and CHG (green) LEDs are on solid. FAULT (red) LED is off, and INV (green) LED could be on or off.

**Figure 5-5, Charging Mode**

- Charging** - Once Charging mode has been enabled, the unit will wait and display "Charging" to determine the charge routine. If the DC voltage is low ( $\leq 12.8$  VDC/12-volt models,  $\leq 25.6$  VDC/24-volt models or  $\leq 51.2$  VDC/48-volt models), the charger will initiate "Bulk Charging". If the DC voltage is high ( $> 12.9$  VDC/12-volt models,  $> 25.6/24$ -volt models or  $> 51.2/48$ -volt models), the charger will skip the Bulk and Absorb charging stages and go directly to Float Charging.

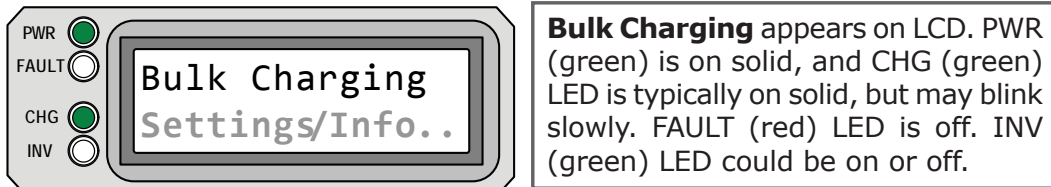

**Bulk Charging** appears on LCD. PWR (green) is on solid, and CHG (green) LED is typically on solid, but may blink slowly. FAULT (red) LED is off. INV (green) LED could be on or off.

**Figure 5-6, Bulk Charging Mode**

- Bulk Charging** - The battery charger is delivering maximum current (determined by the SETUP menu's *05 Charge Rate* setting) to the batteries. The charger will remain in Bulk charge until the absorb voltage (determined by the SETUP menu's *04 Battery Type* setting) is achieved.

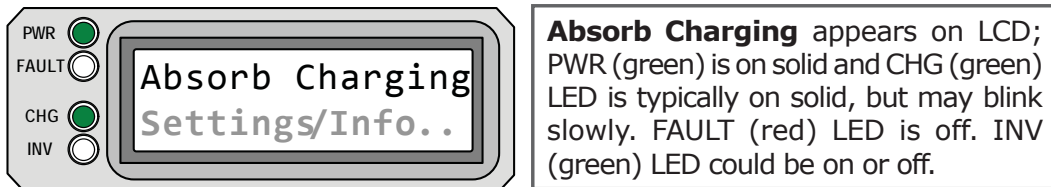

**Absorb Charging** appears on LCD; PWR (green) is on solid and CHG (green) LED is typically on solid, but may blink slowly. FAULT (red) LED is off. INV (green) LED could be on or off.

**Figure 5-7, Absorb Charging Mode**

- Absorb Charging** - The Absorb Charging state is the constant voltage stage and begins when the absorb voltage is reached (determined by the SETUP menu's *04 Battery Type* setting) while Bulk charging. During this stage, the DC charging current decreases in order to maintain the absorb voltage setting. This charge stage continues until the Absorb Charging time (determined by the SETUP menu's *03 Battery AmpHrs* setting) is finished.

## 5.0 Operation

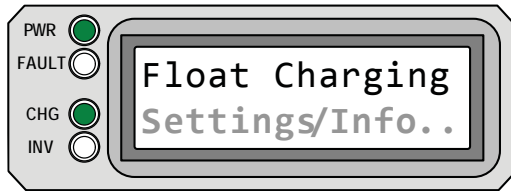

**Float Charging** appears on LCD. PWR (green) LED is on solid, and CHG (green) LED is typically on solid, but may blink slowly. FAULT (red) LED is off, and INV (green) LED could be on or off.

*Figure 5-8, Float Charging Mode*

- **Float Charging** - At the end of the Absorb Charging time, the charger reduces the charge voltage and tries to maintain the batteries at the Float Charge voltage setting. This is determined by the SETUP menu's 04 Battery Type setting as shown in Table 3-3.



**Info:** If the battery voltage falls  $\leq 12.1$  VDC (12-volt models),  $\leq 24.2$  VDC (24-volt models) or  $\leq 48.4$  VDC (48-volt models), the unit will begin Bulk charging.

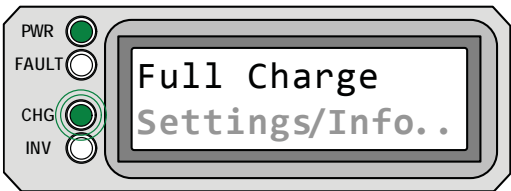

**Full Charge** appears on LCD. PWR (green) LED is on solid, and CHG (green) LED blinks slowly. FAULT (red) LED is off, and INV (green) LED could be on or off.

*Figure 5-9, Full Charge Mode*

- **Full Charge** - This status indicates that you have entered the Battery Saver™ mode. This mode maintains the batteries without overcharging, thus preventing excessive loss of water in flooded batteries or drying out of GEL/AGM batteries. After 4 hours Float Charging, the charger will turn off and "Full Charge" is displayed (charger is now in Battery Saver™ mode). If the battery voltage drops to  $\leq 12.6$  (12-volt models),  $\leq 25.2$  (24-volt models) or  $\leq 50.4$  (48-volt models), the charger will automatically initiate another 4 hours of Float charging. This cycle helps to ensure the batteries are monitored and maintained, and continues as long as AC power is continuously connected to the AC input.



**Charger Standby** appears on LCD. PWR (green) LED is on solid and CHG (green) LED slowly blinks. FAULT (red) LED is off, and INV (green) LED could be on or off.

*Figure 5-10, Charger Standby Mode*

- **Charger Standby** - This means the charger has been disabled to prevent any charging, but the AC power (from shore/utility or generator) to the AC input is still available on the AC output. This display is shown when the ON/OFF CHARGER pushbutton is pressed while the AC power is passing through the inverter/charger.



**Info:** To enable charging again, press the ON/OFF CHARGER pushbutton. When the charger is again enabled, the charger will continue in the Charge mode it last left and the CHG (green) LED will come on solid.

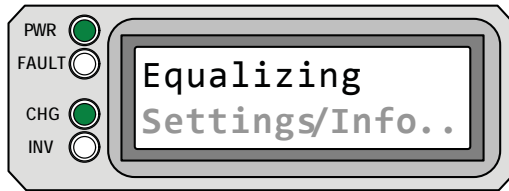

**Equalizing** appears on LCD. PWR (green) and CHG (green) LEDs are on solid. FAULT (red) LED is off, and INV (green) LED could be on or off.

**Figure 5-11, Equalizing Mode**

- **Equalizing** - The battery charger is delivering the equalize voltage to the batteries; see Table 3-3 to determine the equalize voltage for your battery type.

Equalize charging can be enabled by the ON/OFF CHARGER pushbutton – if the SETUP menu's *04 Battery Type* selection allows. Equalization charging can only be enabled while the charger is in Float charge or in Battery Saver mode. To turn on Equalize charging, ensure the LCD display reads "Float Charging" or "Full Charge", then press and hold the ON/OFF CHARGER pushbutton down (about 5 seconds) until the LCD screen displays "Equalizing".

The Equalize charge will continue for 4 hours and then automatically stop and return to Float charging. The Equalize charge can be manually stopped by pressing and holding the ON/OFF CHARGER pushbutton down (about 5 seconds) until the LCD screen displays "Float Charging".

During Equalize charge stage the batteries will begin gassing and bubbling vigorously which consumes water. Ensure each cell has adequate distilled water levels prior to equalizing, and add water as needed after equalizing.

**How often should I equalize?** Some experts recommend that heavily used batteries should be equalized periodically, ranging anywhere from once a month to once or twice per year. Other experts only recommend equalizing when the cells have a low specific gravity, or when the difference between any individual cell has a specific gravity reading greater than .015 after being fully charged.

**How long should I equalize?** While the batteries are gassing, monitor the specific gravity readings every hour. When the specific gravity readings no longer increase, the Equalization charge is complete and should be stopped.



**WARNING:** Equalizing produces hydrogen and oxygen gas. Ensure the battery compartment has adequate ventilation to dissipate this gas to avoid explosions.



**CAUTION:** Ensure you batteries can be equalized – only equalize your batteries if permitted by your battery manufacturer or dealer. Performing an Equalize charge on batteries other than liquid lead acid or certain AGM types could permanently damage them. Refer to your battery manufacturer/dealer for instructions on how to properly equalize your batteries.



**CAUTION:** Ensure the DC loads will not be damaged by the higher voltage applied to the batteries during the Equalize charge. If in doubt, disconnect the DC loads to prevent damage.



**Info:** Equalization charging is not available if GEL or AGM 2 is selected under the SETUP menu's *04 Battery Type* menu.

## 5.0 Operation

### 5.3.3 Fault Mode Messages

The FAULT LED comes on and a fault status is displayed when an abnormal condition is detected. View the LCD display and use the information in this section to determine and correct the issue.



**Info:** Many of the faults will automatically restart when the fault is cleared. Some faults will require a manual restart (ON/OFF INVERTER pushbutton on remote is pressed and released). Finally, if the fault does not clear, an inverter reset may be required.

#### 5.3.3.1 System Fault Messages

These faults are usually caused by an external issue that directly affects the inverter/charger system.

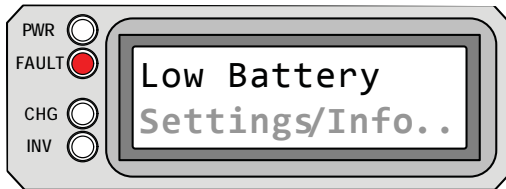

**Low Battery** appears on the LCD. The FAULT (red) LED is on. The PWR (green), CHG (green), and INV (green) LEDs are off.

Figure 5-12, Low Battery Fault

- **Low Battery** - The inverter turned off to prevent the batteries from being over-discharged. "Low Battery" displays, and the FAULT (red) LED illuminates when the battery voltage drops below the SETUP menu's 02 LowBattCutOut (LBCO) setting for more than one minute. The inverter will automatically restart and resume operation when the battery voltage rises to  $\geq 12.5$  VDC (12-volt models),  $\geq 25.0$  VDC (24-volt models), or  $\geq 50.0$  VDC (48-volt models).



**Remedy:** This fault will also automatically restart if AC power is connected to the inverter/charger's input and the battery charging process begins.

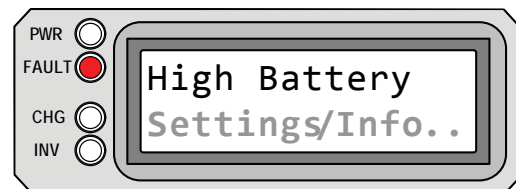

**High Battery** appears on the LCD. The FAULT (red) LED is on. The PWR (green), CHG (green), and INV (green) LEDs are off.

Figure 5-13, High Battery Fault

- **High Battery** - The inverter has turned off because the battery voltage is at a very high level. "High Battery" displays, and the FAULT (red) LED will be on when the battery voltage is above the High Battery Cut-Out (HBCO) value. The inverter will automatically restart and resume operation when the battery voltage drops 0.3 VDC (12-volt models), 0.6 VDC (24-volt models), or 1.2 VDC (48-volt models) below the HBCO value.



**Info:** The HBCO value is dependent on your inverter revision and model. Normally, the HBCO value for ME/MM/RD Series inverters is 16 VDC (12-volt models) or 32 VDC (24-volt models). The HBCO value for MS/MMS Series inverters is 17 VDC (12-volt models), 34 VDC (24-volt models), or 68 VDC (48-volt models).



**Remedy:** This fault usually occurs when an external DC source is charging the inverter's battery bank. Turn off any other additional charging source to allow the DC voltage level to drop.



**Overtemp** appears on the LCD. The FAULT (red) LED is on. The PWR (green), CHG (green), and INV (green) LEDs are off.

**Figure 5-14, Overtemp Fault**

- **Overtemp** - The inverter/charger has shut down because the internal power components (FET's and/or Transformer) have exceeded their safe temperature operating range. When the unit has cooled down, it will automatically restart and continue operation.



**Remedy:** If the fault occurs while inverting, reduce the load on the inverter. If it occurs while charging, turn down the charge rate. If this fault happens often ensure the inverter is not in a hot area, has proper ventilation, and the cooling fans inside the inverter are working.

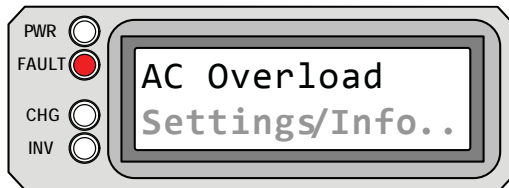

**AC Overload** appears on the LCD. The FAULT (red) LED is on. The PWR (green), CHG (green), and INV (green) LEDs are off.

**Figure 5-15, AC Overload Fault**

- **AC Overload** - This fault message displays when the AC load on the inverter/charger's output has exceeded the inverter's AC current protection limits. If the overload condition lasts for less than 10 seconds, the unit will automatically restart and resume operation. However, if the overload occurs for more than 10 seconds, the unit will shut down and will require a manual restart.



**Remedy:** This fault usually occurs because the connected AC loads are larger than inverter's output capacity, there is a wiring short on the output, or the output wires are incorrectly wired. Once the AC loads are reduced or the output wiring is corrected, the inverter can be restarted after a manual restart has been accomplished.

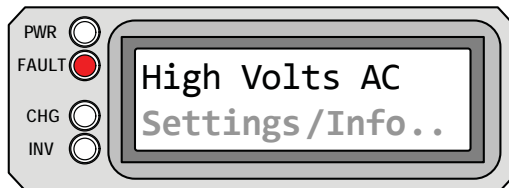

**High Volts AC** appears on the LCD. The FAULT (red) LED is on. The PWR (green), CHG (green), and INV (green) LEDs are off.

**Figure 5-16, High Volts AC Fault**

- **AC High Volts AC** - This fault causes the charger to be disabled because a very high AC voltage (>150 VAC) has been detected on the AC input.



**Remedy:** Remove all AC power from the inverter's AC input for at least 15 minutes to automatically restart this fault. Ensure only 120VAC power is connected to each of the inverter's AC inputs.

## 5.0 Operation

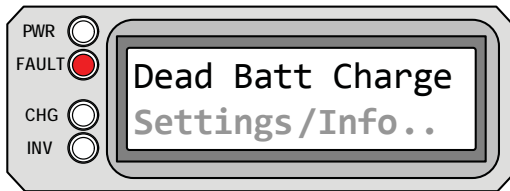

**Dead Battery Charge** appears on the LCD. The FAULT (red) LED is on. The PWR (green), CHG (green), and INV (green) LEDs are off.

**Figure 5-17, Dead Battery Charge Fault**

- **Dead Battery Charge** - This fault has detected a very discharged battery bank, or a battery bank not connected to the inverter. The unit is attempting to enter the Charge mode, but has detected less than 9 volts (12-volt models), 18 volts (for 24-volt models), or 36 volts (for 48-volt models) on the battery bank.



**Remedy:** Check the DC voltage on the inverter's DC terminals and ensure it is the same as the battery bank – these two voltages should be very close (<0.5 VDC difference). If not, check to ensure all connections are tight and the fuse/circuit breaker between the inverter and battery bank is good.

This fault automatically clears when the voltage is greater than 12.6 volts (12-volt models), 25.2 volts (for 24-volt models), or 50.4 volts (for 48-volt models) as detected by the inverter.

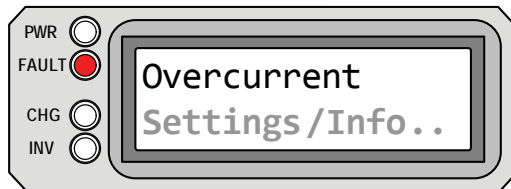

**Overcurrent** appears on the LCD and the FAULT (red) LED is on. The PWR (green), CHG (green) and INV (green) LEDs are off.

**Figure 5-18, Overcurrent Fault**

- **Overcurrent** - This fault shuts down the inverter to protect internal power components. The fault may be caused by an excessive AC load. If the overload condition lasts for less than 10 seconds, the unit will automatically restart and resume operation. However, if the overcurrent condition occurs for more than 10 seconds, the unit will shut down and will require a manual restart.



**Remedy:** This fault usually occurs because the connected AC loads are larger than the inverter's output capacity, there is a wiring short on the AC output, or the wires are incorrectly installed. Once the AC loads are reduced or the output wiring is corrected, manually restart the inverter to resume operation. If this fault condition continues after all these recommendations, perform a inverter reset (see Section 6.2).



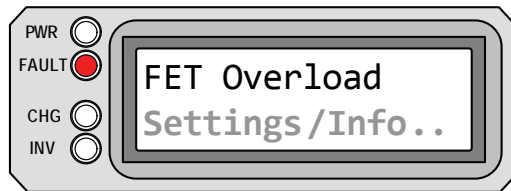

**FET Overload** appears on the LCD. The FAULT (red) LED is on. The PWR (green), CHG (green), and INV (green) LEDs are off.

**Figure 5-19, FET Overload Fault**

- **FET Overload** - This fault message indicates the inverter/charger has shut down because the internal FET's (Field Effect Transistor's) have quickly exceeded a safe operating temperature. When the FET's have cooled, the unit will require a manual restart to resume operation.



**Remedy:** If the fault continues to occur, disconnect all the inverter's AC output wires and reset the inverter (see Section 6.2). If this fault does not clear after doing a reset, the inverter may require service.

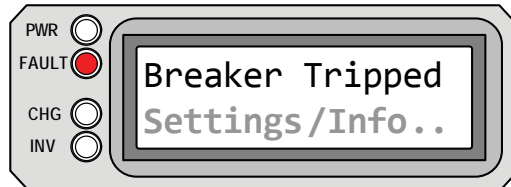

**Breaker Tripped** appears on the LCD. The FAULT (red) LED is on. The PWR (green), CHG (green), and INV (green) LEDs are off.

**Figure 5-20, Breaker Tripped Fault**

- **Breaker Tripped** - The inverter has detected that the AC input breaker on the inverter/charger has opened due to excess current flow through the inverter to the AC loads.



**Remedy:** After reducing the AC loads, push in the inverter's AC input circuit breaker to reset and resume operation.



**Info:** While in Charger mode, the inverter's AC input breaker could nuisance trip if the loads on the inverter's AC HOT OUT 1 exceed the current rating of this circuit breaker.

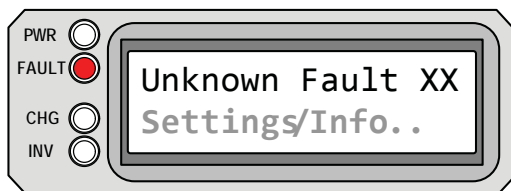

**Unknown Fault XX** appears on the LCD. The FAULT (red) LED is on. The PWR (green), CHG (green), and INV (green) LEDs are off.

**Figure 5-21, Unknown Fault**

- **Unknown Fault** - This fault message displays when the inverter/charger has sent a fault code that cannot be determined by the remote.



**Remedy:** Call the Technical Support department at Magnum Energy to assist you in determining and understanding the actual fault status.



## 5.0 Operation

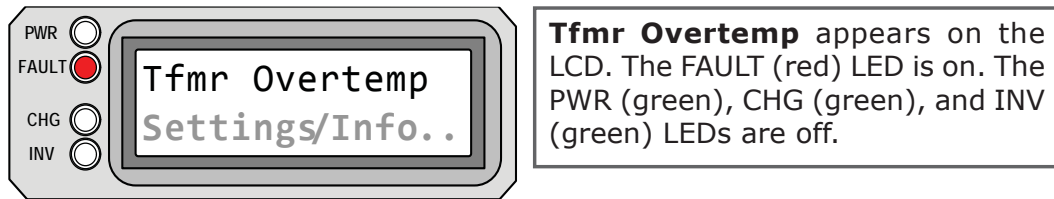

Figure 5-22, *Tfmr Overtemp Fault*

- **Tfmr Overtemp** - This fault message is displayed when the TCO (Temperature Cut-Out) opens and causes the inverter to shut down to protect the internal power transformer from damage. When the TCO has cooled down, the inverter will automatically restart and resume operation.



**Remedy:** If the fault occurs while inverting, reduce the load on the inverter. If it occurs while charging, turn down the charge rate. If this fault occurs often, ensure the inverter is in a cool location, has adequate ventilation, and the internal cooling fans are operational.

### 5.3.3.2 Remote Fault Message

The remote control may not be functioning correctly and can also display a fault condition. Refer to the following fault message to help troubleshoot.

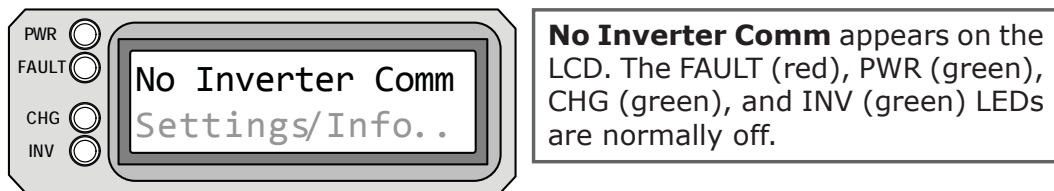

Figure 5-23, *No Inverter Comm*

- **No Inverter Comm** - This fault message indicates that the remote is no longer receiving any communication data via the Magnum Network.



**Remedy:** Reset the remote by disconnecting the remote communications cable from the inverter for 5 seconds, and then reconnect it (see Figure 2-2). If the fault continues, first check/replace the remote cable. This cable is 4-wire telephone cable.

#### What if the cable is not the issue?

- Try another remote display.
- Disconnect the remote from the Remote port and connect to the Network port.
- The inverter might need servicing.

### 5.3.3.3 Stacking Fault Messages

A fault condition may occur when two inverters are stacked in series — using the stacking interface — that is not possible on a single inverter installation. Refer to the following fault messages to help troubleshoot the inverters.



**StackClock Fault** appears on the LCD. The FAULT (red) LED is on. The PWR (green), CHG (green), and INV (green) LEDs are off.

**Figure 5-24, StackClock Fault**

- **StackClock Fault** - There is a stacker cable problem; or, one inverter is losing synchronization with the other inverter.



**Remedy:** Ensure you are using a Magnum Stacking Cable (this is not a telephone/data cable, this is a custom made cable). Inspect the stacker cable and reconnect at both ends (listen and make sure you hear an audible “click” from the connectors at both inverters).



**Info:** This fault has been known to occur when a Magnum Energy accessory is plugged into the Stack port, but the installation is not using multiple inverters in a stacked configuration. If this occurs, perform an [inverter reset](#) (see Section 6.2).

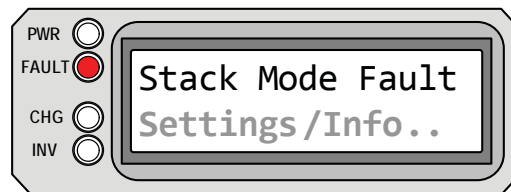

**Stack Mode Fault** appears on the LCD. The FAULT (red) LED is on. The PWR (green), CHG (green), and INV (green) LEDs are off.

**Figure 5-25, Stack Mode Fault**

- **Stack Mode Fault** - This unit has detected a problem with the “other” stacked inverter. Check that unit for a fault condition.



**Remedy:** This fault will automatically clear when the fault with the [other](#) inverter is corrected.

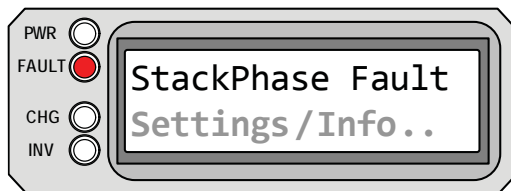

**StackPhase Fault** appears on the LCD. The FAULT (red) LED is on. The PWR (green), CHG (green), and INV (green) LEDs are off.

**Figure 5-26, StackPhase Fault**

- **StackPhase Fault** - 1. The AC input wiring is incorrect; 2. One phase was lost from the AC input source; 3. One of the inverter’s internal transfer relay is bad; or, 4. The inverter’s AC input circuit breaker may be open.



**Remedy:** If this fault doesn’t clear after checking these four recommendations, perform an [inverter reset](#) (see Section 6.2).

## 5.0 Operation

### 5.3.3.4 Internal Fault Messages

The inverter continually monitors several internal components. If an condition inside the inverter occurs that does not allow proper operation, the inverter will shut down to help protect itself. These are referred to as internal faults, and the inverter will require an inverter reset to clear these faults.



**Remedy:** Perform an inverter reset. See Section 6-2. After resetting the inverter, press the ON/OFF INVERTER pushbutton to turn the inverter on and verify the fault has cleared. If the internal fault remains, the inverter will require repair at an authorized service facility.

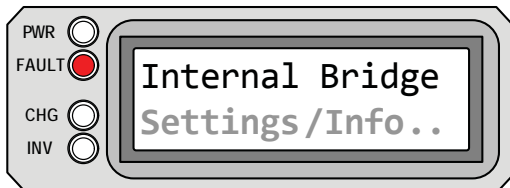

**Internal Bridge** appears on the LCD. The FAULT (red) LED is on. The PWR (green), CHG (green), and INV (green) LEDs are off.

*Figure 5-27, Internal Bridge Fault*

- **Internal Bridge** - This fault message displays and the inverter shuts down because the internal power-bridge protection circuit has been activated.

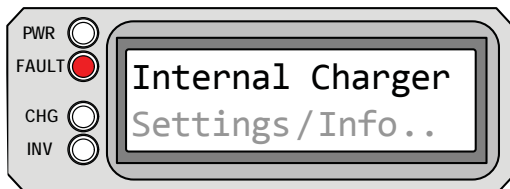

**Internal Charger** appears on the LCD. The FAULT (red) LED is on. The PWR (green), CHG (green), and INV (green) LEDs are off.

*Figure 5-28, Internal Charger Fault*

- **Internal Charger** - This fault message displays and the inverter shuts down because the internal charger protection circuit has been activated.

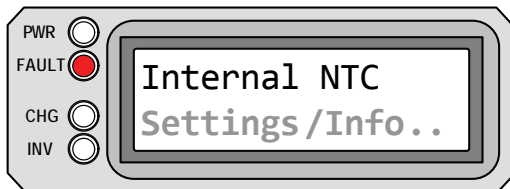

**Internal NTC** appears on the LCD. The FAULT (red) LED is on. The PWR (green), CHG (green), and INV (green) LEDs are off.

*Figure 5-29, Internal NTC Fault*

- **Internal NTC** - This fault message displays and the inverter shuts down because the internal NTC (temperature sensor) circuit has been activated.

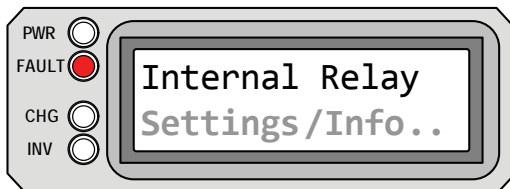

**Internal Relay** appears on the LCD. The FAULT (red) LED is on. The PWR (green), CHG (green), and INV (green) LEDs are off.

*Figure 5-30, Internal Relay Fault*

- **Internal Relay** - This fault message displays and the inverter shuts down because the internal AC transfer relay protection circuit has been activated.

### 5.3.4 LED Indicator Guide

The remote provides the following LEDs; use them along with the LCD display to determine the operating status.

**Table 5-1, LED Indicator Guide**

LED	Status	Meaning
<b>PWR</b> (green)	OFF	1. Inverter is disabled; 2. Remote's in Power Saver mode - press any button to activate LEDs; 3. No power to remote (check remote cable or power to inverter); or, 4. No AC power at the inverter's AC output terminals.
	ON	AC power is available from inverter, shore, or generator at the inverter's AC output terminals.
<b>FAULT</b> (red)	OFF	Normal operation.
	ON	A fault condition has been detected, check the LCD display to find and correct the cause.
<b>CHG</b> (green)	OFF	1. Remote is in Power Saver mode - press any button to activate LEDs; or, 2. Charger off - no utility or AC generator present.
	ON	Bulk, Absorb, Float, or Equalize charge mode (see LCD display to determine charge status).
	BLINKING, display says <i>"Charger Standby"</i> .	The charger is in Charger Standby mode. This occurs when the ON/OFF CHARGER pushbutton is pressed to disable the charger.
	BLINKING, display says <i>"Full Charge"</i> .	The charger is in Battery Saver mode. This mode monitors battery voltage level and only charges if the battery voltage decreases to a low level.
	BLINKING, display shows a charging status (i.e. Bulk, Absorb, Float).	The charger current is automatically decreased because: 1. Charger Back-off - the inverter's internal temperature is getting hot, current is decreased to reduce/maintain temperature; or, 2. Low AC Input Voltage - the input AC voltage is <85 VAC, charger is disabled to help stabilize incoming AC voltage to prevent AC disconnect.
	BLINKING, display does <b>not</b> show any charge status.	The inverter is detecting AC voltage (from utility or an AC generator) on the inverter's AC input terminals.
<b>INV</b> (green)	OFF	1. Inverter is disabled; or, 2. Remote is in Power Saver mode - press any button to activate LEDs.
	ON	Inverter is enabled - 1. Supplying AC power on the output; or, 2. In Standby (if both INV and CHG LEDs are on); the inverter will automatically supply AC power to the loads if shore or generator power is lost.
	BLINKING	Inverter is in Search mode (the AC load is below the SETUP menu's <i>01 Search Watts</i> setting).

## 6.0 Troubleshooting

### 6.0 Troubleshooting

The remote may not be functioning correctly, use the following table to help find a solution.

**Table 6-1, Remote Control Troubleshooting Guide**

Symptom	Possible Cause	Solution
Display shows unrecognizable letters or symbols.	Static electricity may have been discharged into the LCD display.	<b>Refresh Display:</b> press and hold the SELECT button for 10 seconds.
Display shows "fatal error" or "illegal address".	The remote's internal data addressing was unrecognizable.	<b>Reset remote:</b> disconnect remote communications cable from inverter for 5 seconds and reconnect (see Figure 2-2).
LCD text display is locked-up, pressing any pushbutton has no response - may show "revision" or "connecting".	RJ11 connections on communication cable are not making a good connection.	<b>Reset remote:</b> 1) disconnect remote cable from inverter for 5 seconds and reconnect; 2) check RJ11 cable connection on back of remote (see Figure 2-2). <u>Important:</u> ensure the RJ11 connector is pushed into the correct port; you should feel/hear "click" when the connection is made.
	Remote not getting sufficient power from inverter.	Ensure inverter batteries are connected and inverter is operating correctly. Inverter should be able to invert and power AC loads from batteries (ensure no AC power is connected to the inverter AC inputs).
LEDs and backlight are off.	Remote is in Power Saver mode.	Press any button to reactivate remote (or turn Power Saver mode Off).
Remote is nonfunctional (no lights, no text on LCD display, and no response when pressing any pushbutton).	Communication cable bad or not correctly connected to REMOTE port on inverter.	Check communications cable from inverter to remote; ensure: 1) it is connected to the REMOTE port, 2) the correct communications cable is used (a 4-conductor telephone cable may be substituted to determine if cable is good).
	Inverter is not connected to batteries.	Ensure inverter batteries are connected and inverter is operating correctly without any AC power connected (can invert and power AC loads from batteries).

### 6.1 Troubleshooting Tips

#### 6.1.1 Inverter Problems

- **Inverter turned on, green INV LED on inverter blinking, no output:** Inverter is in Search mode. Either turn off Search mode — if not needed — or turn on loads greater than the *Search Watts* setting (page 8).

#### 6.1.2 Charger Problems

- **Unit won't transfer to Charge mode with AC applied:** Is charge (CHG) LED on remote blinking? If not, then the charger does not recognize the incoming AC being within acceptable limits. Measure the input AC voltage, it should be 120VAC +/- 20 VAC. Also, check that the *VAC Dropout* setting (p. 14) on the remote is 80 VAC or less. If the CHG LED is blinking, the transfer relay should close within 20 seconds and the unit should then begin charging. If the LED is on solid, the transfer relay should already be closed and the charger should be charging.

- **Transfer relay closes, then opens and continues to cycle:** AC voltage is too low, or has transients that drop the AC voltage momentarily. Change the *VAC Dropout* setting (p. 14) to 60 VAC and check for improvements. If the cycling continues, back off the *Charge Rate* from 100% to 10% (p. 13).

This cycling may also occur if the AC output of the inverter is connected to the inverter's AC input. Check for proper input and output AC wiring.

- **Charger not charging even though CHG LED is on steady and the unit says "Charging":** Full charge rates are not obtained in Charging mode, only after this mode changes to Bulk Charging, Absorb Charging, or Float Charging modes.

- **Charger not charging even though CHG LED is on steady and the unit says "Bulk Charging" (or "Absorb Charging"):** Check the *01B DC Amps* and the *01A DC Volts* meters (p. 7) on the ME-RC display, it should be 80% or more of rated charge current if the battery voltage is under 14.0 VDC (28.0 VDC on 24-volt models or 48.0 VDC for 48-volt models). If not, check the *03C Max Charge Rate* setting (p.13) and verify the setting is 80% or greater. Still low charge rate? Check the *Shore Amps* setting (p. 6) to verify. If no AC loads are being 'passed thru' the inverter, the *Shore Amps* setting must be 15 amps (25 amps for 3kW unit) or greater, to receive full charge rate.

- **Charger says "Float Charging" not "Bulk Charging" when the AC is first plugged in:** Check the *01A DC Volts* meter (p. 7) on the ME-RC display, if the battery is over 13.0 VDC (26.0 VDC for 24-volt models or 52.0 VDC for 48-volt models) then the battery was already charged, and the charger automatically goes to Float Charging to keep from overcharging the batteries.

- **Charge amps are lower than expected, or is 0 amps DC:** Measure input AC voltage and increase if the input voltage is under 90 VAC. The charge rate is reduced to try and keep the input voltage above 90 VAC; also check the *Shore Max* (p. 6) and *03C Max Charge Rate* (p. 13) settings to determine if the current is being limited.

- **Charger output voltage is higher than expected:** Check the Battery Temperature Sensor (BTS) temperature. If the BTS is installed, the charge voltage settings will increase if the temperature around the BTS is below 77° F (25° C), and will decrease if the temperature around the BTS is higher than 77° F (25° C).



## 6.0 Troubleshooting

### 6.2 Performing an Inverter Reset

Press and hold the Power ON/OFF pushbutton (see Figure 6-1) for approximately fifteen (15) seconds until the Charging/Inverting Status LED comes on and flashes rapidly. Once the rapid flashing has begun, release the Power ON/OFF pushbutton. The Status LED will go off after the pushbutton is released.

After the inverter reset is completed, press the ON/OFF pushbutton to turn the inverter ON.

Some older inverter models do not allow an inverter reset. If the inverter reset fails, you will need to power-down the inverter using the procedure below. In either case, if an internal fault does not clear, the inverter will require repair at an authorized service facility.



**Info:** The Power ON/OFF pushbutton is a small momentary type switch which operates by lightly pressing and releasing.



**Info:** All adjustable inverter/charger settings in the ME-RC (except for the SHORE menu's *Shore Max* and SETUP menu's *08 Screen Setup* settings - which revert back to default) are saved in nonvolatile memory and are preserved until changed - even if an inverter reset is performed, or if all power to the remote or inverter is removed.



1. Press and hold the Power ON/OFF pushbutton for 15 seconds.

2. Watch the Charging/Inverting Status LED, after approximately 15 seconds it should come on and flash rapidly to indicate the inverter has reset. The Status LED will go off after the pushbutton is released.

*Figure 6-1, Performing an Inverter Reset*

### 6.3 Powering-down the Inverter

Perform the following steps to power-down the inverter:

1. Remove all AC power (utility or generator power) to the inverter.
2. Disconnect the positive battery cable to the inverter.
3. Ensure the inverter and remote control are disconnected from all AC and DC power (the remote display will be blank).

After the inverter has been disconnected from all power for 30 seconds, reconnect the positive battery cable and resume operation.



**Info:** There may be a momentary spark when the positive battery cable is connected to the inverter's terminal. This is normal and indicates that the inverter's internal capacitors are being charged.



### 7.0 Service and Warranty Info

Magnum Energy, Inc. warrants the ME-RC remote control to be free from defects in material and workmanship that result in product failure during normal usage, according to the following terms and conditions.

1. The limited warranty for this product extends for a maximum of 12 months from the product's original date of purchase.
2. The limited warranty extends to the original purchaser of the product and is not assignable or transferable to any subsequent purchaser.
3. During the limited warranty period, Magnum Energy will repair, or replace at Magnum Energy's option, any defective parts, or any parts that will not properly operate for their intended use with factory new or remanufactured replacement items if such repair or replacement is needed because of product malfunction or failure during normal usage. The limited warranty does not cover defects in appearance, cosmetic, decorative or structural parts or any nonoperative parts. Magnum Energy's limit of liability under the limited warranty shall be the actual cash value of the product at the time the original purchaser returns the product for repair, determined by the price paid by the original purchaser. Magnum Energy shall not be liable for any other losses or damages.
4. Upon request from Magnum Energy, the original purchaser must prove the product's original date of purchase by a dated bill of sale, itemized receipt.
5. The original purchaser shall return the product prepaid to Magnum Energy in Everett, WA. After the completion of service under this limited warranty, Magnum Energy will return the product prepaid to the original purchaser via a Magnum-selected nonexpedited surface freight within the contiguous United States and Canada; this excludes Alaska and Hawaii.
6. If Magnum repairs or replaces a product, its warranty continues for the remaining portion of the original warranty period or 90 days from the date of the return shipment to the original purchaser, whichever is greater. All replaced products and parts removed from repaired products become the property of Magnum Energy.
7. This limited warranty is voided if:
  - the product has been modified without authorization
  - the serial number has been altered or removed
  - the product has been damaged through abuse, neglect, accident, high voltage or corrosion
  - the product was not installed and operated according to the owner's manual

**BEFORE RETURNING ANY UNIT, CONTACT MAGNUM ENERGY FOR A RETURN MATERIAL AUTHORIZATION (RMA) NUMBER**

## 7.0 Service and Warranty Info

### 7.1 How to Receive Repair Service

If your product requires warranty service or repair, contact either:

1. An Authorized Service Center, as listed on the Magnum Energy website at <http://www.magnumenergy.com/ServiceCenters.htm>, or
2. Magnum Energy, Inc. at:

Telephone: 425-353-8833

Fax: 425-353-8390

Email: [warranty@magnumenergy.com](mailto:warranty@magnumenergy.com)

If returning your product directly to Magnum Energy for repair, you must:

- return the unit in the original, or equivalent, shipping container
- receive a Return Materials Authorization (RMA) number from the factory
- prior to the return of the product to Magnum Energy for repair
- place RMA numbers clearly on the shipping container or on the packing slip

When sending your product for service, please ensure it is properly packaged.

**Damage due to inadequate packaging is not covered under warranty.**

We recommend sending the product by traceable or insured service.



Magnum Energy, Inc.  
2211 West Casino Rd  
Everett, WA 98204  
Phone: 425-353-8833  
Fax: 425-353-8390  
Web: [www.magnumenergy.com](http://www.magnumenergy.com)